

SECTION 2

CHEMICALS

ITEM NUMBER	CONTROL NUMBER	PRODUCT DESCRIPTION	PRICE
3" TRICHLOR CHLORINE TABLETS			
72234	16C015221	Pail 4#	\$25.37
722384	17C116579	Case 8 x 4#	\$194.28
722310	71C038066	Pail 10#	\$63.43
7223410	72C145717	Case 4/10#	\$242.85
722325	18C084078	Pail 25#	\$101.29
722350	20C168147	Pail 50 #	\$186.82
722350-3		Pail 50#, 3 or more	Call us !

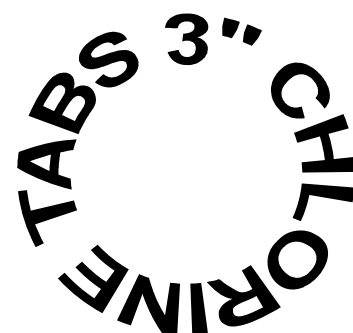

1" TRICHLOR CHLORINE TABLETS			
72214	09C015228	Pail 4#	\$25.37
722184	10C116574	Case 8 x 4#	\$194.28
722120	11C071041	Pail 20#	\$88.80
722150	13C168146	Pail 50#	\$186.82
722150-3		Pail 50#, 3 or more	Call us !

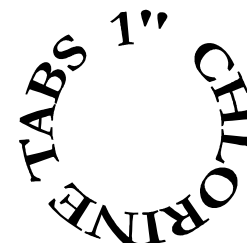

GRANULAR DICHLOR CHLORINE			
72154	01C016482	Pail 4#	\$27.47
721584	02C127883	Case 8 x 4#	\$213.13
722120	03C073757	Pail 20#	\$98.33
722150	07C184386	Pail 50#	\$230.48

CHLORINE STABILIZER-Cyanuric acid			
73384	21C009930	Pail 4#	\$13.79
733884	22C075685	Case 8 x 4#	\$105.11
73312	23C005231	Jar 2# Powder	\$7.26
733124	24C060616	Case 12 x 2#	\$84.18



CHLOR-OUT--- (CHLORINE NEUTRALIZER—Sodium Sulfite)			
R1492-1	45C005532	Jar 2# Powder	\$7.79
R1492-12	46C064230	Case 12 x 2#	\$90.46
R1492-25	97C049901	25# Pail	\$70.28



BROMINE TABS---FOR POOLS & SPAS			
72584	01B026442	Pail 4#	\$35.73
725884	02B201246	Case 8 x 4#	\$271.95
725825	03B117234	Pail 25#	\$127.42
725850	04B199955	Pail 50#	\$208.28
725850-2	04B193341	Pail 50#, 3-5 drums	\$201.40
725850-3	04B188595	Pail 50#, 6 or more drums	\$196.45



SECTION 2

CHEMICALS

ITEM NUMBER	CONTROL NUMBER	PRODUCT DESCRIPTION	PRICE
-------------	----------------	---------------------	-------

LIQUID CHLORINE-*Sodium Hypochlorite*

R1050-5	01U005013	Single gallon container	\$6.68
R1050-7	02U017509	Case 4 x 1 gallon containers	\$23.33
R1050-710	03U016674	Case lots 10 or more	\$22.22

LIQUID CHLORINE

CARBOYS--5 Gallon Chlorine

R1050-6	04U018795	Carboy 5 gallon	\$23.49
R1050-610	06U016691	Carboy 5 gallon, 10 or more	\$20.86
DEP	05U006000	Carboy deposit	\$6.00
CCW	085U00304	Carboy Cap Wrench	\$30.00

LIQUID ACID-*Muriatic Acid*

R1050-8	06U007241	Single gallon container	\$9.65
R1050-9	07U026301	Case 4 x 1 gallon container	\$35.07
R1050-910	08U023891	Case lots 10 or more	\$31.85

LIQUID ACID

SHOCK TREATMENT

OXY CLEAR---*Non-chlorine shock, 100% Pure, 43% Active PMP*

R105-2½	50C008976	Jar 2# Powder	\$12.63
R105-24	52C103951	Case 12 x 2#	\$146.41
R105-5	51C018334	Pail 5#	\$25.32
R105-40	53C141677	Case 8 x 5#	\$199.54
R105-20	54C066946	Pail 20#	\$94.28
R105-50	55C159025	Pail 50#	\$223.97



LITHIUM HYPOCHLORITE ---*For shock & chlorination*

R161	85C011636	Duo Shock, Bottle 2# Powder	\$16.38
R161-12	86C134924	Duo Shock, Case 12 x 2#	\$190.03
R161-50	93C261482	Lithium hypochlorite, 50# Pail	\$326.79

CALCIUM HYPOCHLORITE-*For shock & chlorination*

R6355	29C003383	ProTeam, Bag 1# Powder	\$4.57
R6355-12	30C038438	ProTeam, Case 12 x 1#	\$51.96

SECTION 2

CHEMICALS

ITEM NUMBER	CONTROL NUMBER	PRODUCT DESCRIPTION	PRICE
-------------	----------------	---------------------	-------

POOL FIRST AID: For disastrous emergencies...contains powerful enzymes & clarifier.
Clean-up dead algae, oil spills, antifreeze residue & other contamination.

03122	14NC018688	Single 2 Liter First Aid	\$26.69
03122-6	14NC108659	Case of 6-2 liter First Aid	\$155.21



PHOSfree Treats pools with high phosphate levels 300-1000 ppb.

05221	80NC018989	Single 2-liter PHOSfree (Treats 40,000)	\$27.11
05221-6	81NC110409	Case of 6/2-liter PHOSfree	\$157.71
05121	82NC025328	Single 3-liter PHOSfree (Treats 60,000)	\$36.17
05121-4	82NC098158	Case of 4/3-liter PHOSfree	\$140.21
05236	83NC044339	3-liter PHOSfree (commercial strength)	\$63.33

**NATURAL
CHEMISTRY**

POOL PERFECT + PHOSfree

The ultimate combination of phosphate removal and natural enzymes

05235	35NC032866	Single 2 Liter POOL PERFECT + PF	\$46.94
05235-6	47NC191084	Case of 6/2-Liter POOL PERFECT + PF	\$272.97
05131	36NC048172	Single 3 Liter POOL PERFECT + PF	\$68.82
05131-4	51NC186773	Case of 4/3-Liter POOL PERFECT + PF	\$266.82



POOL PERFECT--Enzymes eliminate oily scum lines & increase chlorine efficiency

03210	09Y014435	1 Liter Bottle POOL PERFECT	\$20.61
03210-12	10Y167821	Case 12 x 1 Liter POOL PERFECT	\$239.74
03220	11Y023380	2 Liter Bottle POOL PERFECT	\$33.29
03220-6	12Y135960	Case 6 X 2 Liter POOL PERFECT	\$194.23



METALfree - Phosphate-free metal deactivator

07001	90NC017678	1-Liter METALfree	\$25.24
07001-12	91NC205488	Case 12/1 Liter METALfree	\$293.54

SALT WATER MAGIC-Monthly

Provides the perfect pool water environment continuously for chlorine generators

07404	85NC031061	Single <i>monthly</i> kit (treats 20K gals.)	\$44.37
-------	------------	--	---------

FOUNDATION Prepares pool/spa water for long term quality

7405	24NC024704	5# Pail (Borate Blend)	\$35.29
7415	25NC067175	16.5# Pail (Borate Blend)	95.96



POOL MAGIC --Enzyme Treatment---Treats 20K gals.

Wake your pool up and put it to bed with cold water Treatment

03722	18NC013409	Single 1 Liter (Enzyme only) (Spring)	\$19.14
03722-12	19NC155823	Case of 12/1 Liter	\$222.60
5141	20NC018114	Single 1 Liter (Phosphate Combo) (Fall)	\$25.87

**NATURAL
CHEMISTRY**

ITEM NUMBER	CONTROL NUMBER	PRODUCT DESCRIPTION	PRICE
-------------	----------------	---------------------	-------

ALGAECIDES

ALGAE-ZONE "60"--- 60% Concentrate

R1031-1	40C016153	Bottle 32 oz	\$22.75
R1031-12	41C187317	Case 12 x 32 oz	\$263.81
R1030-1	42C062721	Single gallon	\$88.30
R1030-4	43C357072	Case 6 x 1 gallon	\$502.90

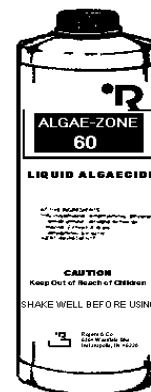

SILVER ALGAECIDE-- Stubborn algae including "pink slime"

R6320	48C017887	Bottle 32 oz	\$24.16
R6320-12	49C203958	Case 12 x 32 oz	\$275.61

STAIN PREVENTION & REMOVAL

SEQUEST--- Stain & scale protection

R1035-1	63C009055	Bottle 32 oz	\$12.75
R1035-12	64C103738	Case 12 x 32 oz	\$146.10
R1035-2	65C033304	Single gallon	\$46.48
R1035-4	66C189332	Case 6 x 1 gallon	\$266.66

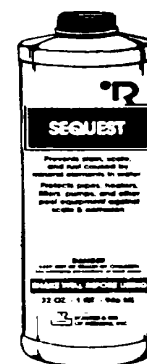

SCALE-free --- Prevents calcium & mineral scale build-up

R07511	12NC028167	2-Liter Scale-free	\$40.23
--------	------------	--------------------	---------

METALfree - Phosphate-free metal deactivator

07001	90NC017678	1-liter Pool METALfree	\$25.24
07001-12	91NC205488	Case 12/1 liter Pool METALfree	\$293.54



STAIN ELIMINATOR--Removes ugly iron & copper stains

R1208-1	83C0016041	Jar 2# Powder	\$22.59
R1208	84C0185985	Case 12 x 2#	\$261.94

WATER CLARIFIERS

NATURE'S POOL CLEAR--- Chitin based 4-in-1 Clarifier

R6340	57C012205	32 oz Bottle	\$16.49
R6340-12	58C140658	Case 12 x 32 oz	\$190.07

POWER FLOC-- Liquid flocculant

R6330	33C007238	Bottle 32 oz	\$9.77
R6330-12	340082966	Case 12 x 32 oz	\$112.11

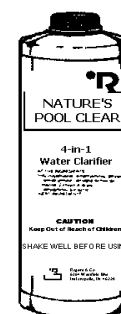

SECTION 2

CHEMICALS

ITEM NUMBER	CONTROL NUMBER	PRODUCT DESCRIPTION	PRICE
-------------	----------------	---------------------	-------

WATER BALANCERS

pH INCREASER---Sodium carbonate

R4524	25C012161	Pail 10#	\$16.43
R4524-4	26C046913	Case 4 x 10#	\$63.39
R1050-02	09U034428	50# bag	\$43.03

pH DECREASER---Sodium Bisulfate

R4109	27C007836	Pail 5#	\$10.58
R4109-4	28C059784	Case 8 x 5#	\$80.78
R4109-50	29C034895	50# Bag	\$47.15

TOTAL ALKALINITY INCREASER---Sodium bicarbonate

R6370	38C011849	Pail 10#	\$15.99
R6370-4	39C045703	Case 4 x 10#	\$61.76
R2513	40C027524	25# Pail	\$37.19
R6370-50	41C032986	50# bag	\$44.57

CALCIUM HARDNESS INCREASER--- Calcium chloride

R6380	36C013047	Pail 10#	\$17.62
R6380-4	37C050279	Case 4 x 10#	\$67.93
R6380-50	84C047318	50# Pail	\$63.93

SPECIALTY CHEMICALS

POOL ANTI-FREEZE- For winterizing pools & spas

R10306-1	01AF07174	Gallon jug	\$9.56
R10306-2	02AF040317	Case 6 x 1 gallon	\$53.75

STOP LEAK--- Stops minor water leaks

R482200	01S032138	Stop Leak Bottle 32 oz	\$45.90
---------	-----------	------------------------	---------



SECTION 2

CHEMICALS

ITEM NUMBER	CONTROL NUMBER	PRODUCT DESCRIPTION	PRICE
-------------	----------------	---------------------	-------

OIL & SCUM ABSORBERS

R9987	05SL04384	SCUMBUG, controls oily water line	\$6.26
R9988	07SL05426	ULTRAMITT--fits the hand, cleans scum	\$7.74

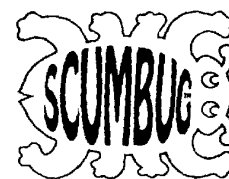

CLEANING CHEMICALS

FILTER CLEANER---Cleans sand, cartridges & DE elements

R1033-1	69C005274	Bottle 32 oz	\$7.42
R1033-12	70C060519	Case 12 x 32 oz	\$85.23

TILE & VINYL CLEANER--All purpose pool cleaner

R1040-91	73C005446	Bottle 32 oz	\$7.66
R1040-12	74C062516	Case 12 x 32 oz	\$88.04

STAINLESS STEEL CLEANER

R70947	95C005452	Bottle 32 oz	\$7.69
R7094I	96C062943	Case 12 x 32 oz	\$88.65

COVER CLEANER & DEODORIZER

R4425	77C006293	Bottle 32 oz	\$8.50
R4425-12	78C069504	Case 12 x 32 oz	\$93.92

WIPE OUT--- The "Eco Friendly" cleaner

R1050	81C009271	Bottle 32 oz	\$12.52
R1050-12	82C106432	Case 12 x 32 oz	\$143.82



SECTION 2

SPA CHEMICALS

SPA PERFECT--Enzymes eliminate oily scum lines & increase chlorine efficiency

4131	09Y012895	1 Liter Bottle SPA PERFECT	\$18.41
4131-12	10Y149917	Case 12 x 1 Liter SPA PERFECT	\$214.16

4034	09Y022515	2 Liter Bottle SPA PERFECT	\$32.16
4034-6	10Y130899	Case 6 x 2 Liter SPA PERFECT	\$186.99

SPA PURGE-Cleans sludge and sediment out of spa piping

4137	09Y013255	1 Liter Bottle SPA PURGE	\$18.93
4137-12	10Y154159	Case 12 x 1 Liter SPA PURGE	\$220.21

**NATURAL
CHEMISTRY**

SECTION 2

SPA CHEMICALS

ITEM NUMBER	CONTROL NUMBER	PRODUCT DESCRIPTION	PRICE
-------------	----------------	---------------------	-------

BROMINE TABLETS

72584	01B026442	Pail 4#	\$35.23
7258484	02B201241	Case 8 x 4#	\$271.95
725825	03B117234	25# Pail	\$127.42

725850	04B199955	Pail 50#	\$208.28
725850-2	04B193541	Pail 50#, 3-5 drums	\$201.40
725850-3	04B188592	Pail 50#, 6 or more drums	\$196.45

DUO SHOCK--- Lithium shock for pools & spas

R161	85C011636	Bottle 2# Powder	\$16.38
R161-12	86C134924	Case 12 x 2#	\$190.03

PREVENT--- Stain & scale control

R164-5	87C009513	Bottle 32 oz	\$13.39
R164-6	88C108844	Case 12 x 32 oz	\$153.30

SPA METAL-FREE --- Phosphate-free metal deactivator

R4133	92NC13251	1-Liter Spa Metal-Free	\$18.93
-------	-----------	------------------------	---------

DEFOAMER-- -Controls foaming

R165-5	93C012094	Bottle 32 oz	\$17.03
R165-6	94C138528	Case 12 x 32 oz	\$195.10

WATER BRITE-- -Spa water clarifier

R169-1	95C006634	Bottle 32 oz	\$9.34
R169-2	96C076948	Case 12 x 32 oz	\$108.37

ALKALINITY PLUS---Sodium Bicarbonate

R177-1	21H002677	Bottle 1# Powder	\$3.76
R177-12	22H031032	Case 12 x 1#	\$48.70

pH PLUS---Sodium carbonate

R175-1	99C002291	Bottle 1# Powder	\$3.23
R175-12	97C026589	Case 12 x 1#	\$37.44

pH MINUS---Sodium bisulfate

R176-1	98C002932	Bottle 1-1/2# Powder	\$4.13
R176-12	98C033908	Case 12 x 1-1/2#	\$47.75

BROMINE TABS

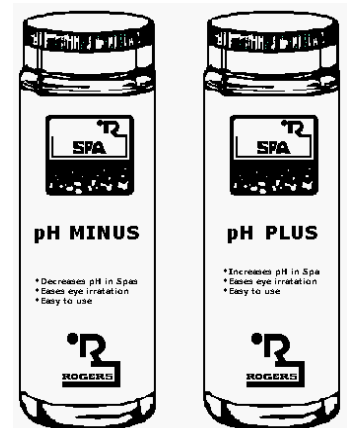
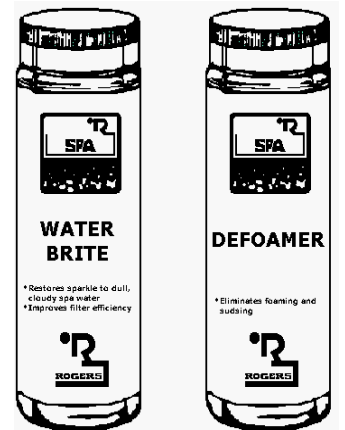

SECTION 3

WATER TESTING

ITEM NUMBER	CONTROL NUMBER	PRODUCT DESCRIPTION	PRICE
-------------	----------------	---------------------	-------

TAYLOR TEST KITS

COMMERCIAL TEST KITS

K2005	25Y040373	Complete™ High Range DPD Test Kit: Free & Total chlorine .5-5 PPM Bromine 1-10 PPM pH 7.0-8.0 Acid and base demand Total alkalinity Calcium hardness cyanuric acid	\$57.67
K2005C	26Y085884	Complete™ High Range DPD Test Kit with 2oz Reagents (Performs same test as K2005 Above)	\$122.69
K2006	59T060601	Complete™ Chlorine FAS-DPD Titration Test Kit: (Using powders to improve accuracy) Same as K2005 except uses 9058 comparator, sanitizer tests are titrations to improve accuracy & eliminate color-matching problems.	\$86.57
K2106	36Y056523	Complete™ Bromine FAS-DPD Titration test kit: (Using powders to improve accuracy) Sanitizer tests are titrations to eliminate color matching problems.	\$80.74



LaMotte---Water Testing

2056	37LA129239	ColorQ Pro 7 Digital Test Kit	\$184.61
------	------------	-------------------------------	----------

Selected LaMotte test reagents in stock-others available upon request.

TAYLOR REPLACEMENT REAGENTS

R-0001	25T02271	#1 DPD, ¼ oz bottle	\$3.24
R-0001-2	44T05204	#1 DPD, 2 oz bottle	\$7.43
R-0002	26T02311	#2 DPD, ¼ oz bottle	\$3.30
R-0002-2	45T05340	#2 DPD, 2 oz bottle	\$7.63
R-0003	27T02637	#3 DPD, ¼ oz bottle	\$3.76
R-0003-2	46T05572	#3 DPD, 2 oz bottle	\$7.96
R-0004	43T01957	#4 pH, ¼ oz bottle	\$2.79
R-0004-2	47T03680	#4 pH, 2 oz bottle	\$5.26
R-0004-4	91T07314	#4 pH, 4 oz bottle	\$10.44
R-0867	95T06725	#0867 ¼ oz bottle DEOX	\$9.60
R-0867-2	85T09805	#0867-2 2 oz bottle DEOX	\$13.99



SECTION 3

WATER TESTING

ITEM NUMBER	CONTROL NUMBER	PRODUCT DESCRIPTION	PRICE
TAYLOR REPLACEMENT REAGENTS			
R-0005	28T02255	#5 ADR Sulfuric acid, ¼ oz	\$3.21
R-0005-2	90T03639	#5 ADR Sulfuric acid, 2 oz	\$5.19
R-0006	29T02255	#6 BDR Sodium Carb, ¼ oz	\$3.21
R-0006-2	89T03468	#6 BDR Sodium Carb, 2 oz	\$4.94
R-0007	30T02087	#7 Thiosulfate, ¼ oz	\$2.97
R-0007-2	31T03358	#7 Thiosulfate, 2 oz	\$4.79
R-0008	49T02020	#8 Total Alkalinity, ¼ oz	\$2.89
R-0008-2	48T03438	#8 Total Alkalinity, 2 oz	\$4.90
R-0009	32T02029	#9 Sulfuric Acid, ¼ oz	\$2.89
R-0009-2	50T03290	#9 Sulfuric Acid, 2 oz	\$4.70
R-0010	33T02520	#10 Calcium Buffer ¼ oz	\$3.60
R-0010-2	88T04185	#10 Calcium Buffer, 2 oz	\$5.97
R-0011L	34T03821	#11 Calcium Indicator , ¼ oz	\$5.46
R-0011P	35T06032	#11 Calcium Indicator, 2 oz	\$8.61
R-0012	36T02493	#12 Hardness Reagent, ¼ oz	\$3.56
R-0012-2	37T03749	#12 Hardness Reagent, 2 oz	\$5.34
R-0013	87T02051	#13 Cyanuric Acid, ¼ oz	\$2.93
R-0013-2	86T03056	#13 Cyanuric Acid, 2 oz	\$4.36
R-0014	93T01281	#14 pH Indicator, ¼ oz	\$1.83
R-1003J	61T03126	#R-1003J pH Indicator, Phenol Red, ¼ oz	\$4.46
R-1003JC	62T04184	#R-1003J pH Indicator, Phenol Red, 2 oz	\$5.97
R-870	63T05891	#R-870 DPD Powder, 10 gram	\$8.41
R-871A	64T06375	FAS-DPD ChlorineTitrating Reagent, 3/4 oz	\$9.10
R-871C	18T08286	FAS-DPD ChlorineTitrating Reagent, 2 oz	\$11.83
R-872A	67T06269	FAS-DPD, Bromine Titrating reagent, ¼ oz	\$8.94
R-872C	68T08384	FAS-DPD, BromineTitrating reagent, 2 oz	\$11.97
R9056	75T06510	#R9056 Comparator, "High" Cl/Br	\$9.30
R0600DB	18T01187	#R0600 Bromine Reagent, ¼ oz	\$1.69
R0004E	42T11432	Phenol Red, pint bottle	\$16.37



SECTION 3

WATER TESTING

ITEM NUMBER	CONTROL NUMBER	PRODUCT DESCRIPTION	PRICE
-------------	----------------	---------------------	-------

RESIDENTIAL TEST KITS & REAGENTS

"All-in-One" 4-Way Test Kit : Chlorine, PH,
Total Alkalinity and Acid Demand

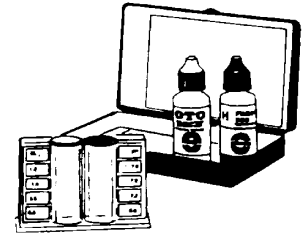

151186	01T015124	Single 4-in-1 test kit	\$20.16
151186-6	02T167458	Case of 12/4-in-1 test kits	\$223.27

REAGENTS FOR 6-in-1 kit

161025	03T001221	#1 OTO , 1 oz. bottle	\$2.03
161025-24	04T026951	Case 24 x 1 oz. #1 bottle	\$44.92

161180	05T001232	#2 Phenol Red, (pH) 1 oz. bottle	\$2.05
161180-24	06T027522	Case 24 x 1 oz. #2 bottles	\$45.53

161182	07T001223	#3 Acid Demand, 1 oz. bottle	\$2.03
161182-24	08T026953	Case 24 x 1 oz. #3 bottles	\$44.92

161204	09T001124	#4 Neutralizer, ½ oz. bottle	\$1.87
161204-24	10T024744	Case 24 x ½ oz. #4 bottles	\$41.23

161203	11T001225	#5 T.A. Indicator, ½ oz. bottle	\$2.03
161203-24	12T026955	Case 24 x ½ oz #5 bottles	\$44.92

161200	13T001106	#3B Alkalinity Demand, ½ oz bottle	\$1.83
161200-24	14T024376	Case 24 x ½ oz #3B bottles	\$40.62



pH



OTO

ECONOMY TEST KIT & REAGENTS

151076	20T005548	Duo Test Kit, 2-in-1, pH/chlorine	\$8.52
--------	-----------	-----------------------------------	--------

161018	21T001101	Phenol Red reagent (pH), ½ oz	\$1.69
--------	-----------	-------------------------------	--------

161004	22T001102	OTO reagent, ½ oz	\$1.69
--------	-----------	-------------------	--------

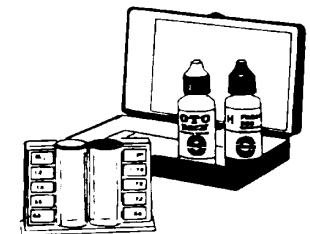

WATER ANALYSIS REAGENTS

161593	43T003727	DPD #1, 50 Tablet pack	\$5.31
--------	-----------	------------------------	--------

161599	44T003868	DPD #3, 50 Tablet pack	\$5.51
--------	-----------	------------------------	--------

161676	46T002986	Cyanuric Acid, 20 tablet pack	\$4.26
--------	-----------	-------------------------------	--------

SECTION 3

WATER TESTING

ITEM NUMBER	CONTROL NUMBER	PRODUCT DESCRIPTION	PRICE
-------------	----------------	---------------------	-------

AQUA-CHEK TEST STRIPS

YELLOW: Free chlorine, pH, total alkalinity and stabilizer

511242A	52T006188	50 Test strip bottle	\$8.83
511242-12	12T068004	Case 12/50 test strip bottles	\$97.14



RED: Bromine, pH, total alkalinity and total hardness

511252A	53T006367	50 Test strip bottle	\$9.09
511252-12	15T069995	Case 12/50 test strip bottles	\$99.99



7-Way: Free & total chlorine/bromine, pH, total alkalinity, cyanuric acid & total hardness

551236	54T017826	100 Test strip bottle	\$25.46
551236-6	60T097994	Case of 6-100 test strip bottles	\$139.99



Multi-Test Strips: Cyanuric Acid, TDS, LR Hardness and HR Hardness

512084	76T008559	Multi-Test Strips: 25 Test strip bottle	\$12.21
--------	-----------	--	---------

661455	60T019994	Iron: 25 Test strip bottle	\$28.56
--------	-----------	-----------------------------------	---------



661454	61T008185	Copper: 25 Test strip bottle	\$11.69
--------	-----------	-------------------------------------	---------

561140	56T007551	Salt: 10 Test strip bottle	\$10.79
--------	-----------	-----------------------------------	---------

542228	57T009090	Salt System Test kit: (1- 25 Test Chlorine strip bottle & 1- 10 Test Salt strip bottle)	\$12.99
--------	-----------	---	---------



SECTION 4

CHEMICAL FEEDERS

ITEM NUMBER	CONTROL NUMBER	PRODUCT DESCRIPTION	PRICE
-------------	----------------	---------------------	-------

FLOATING FEEDERS

CF330	04K07268	Adjustable chlorine dispenser #330	\$11.16
BF335	05K07742	Adjustable bromine/chlorine dispenser For spas and small pools	\$11.91

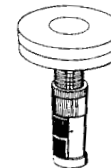
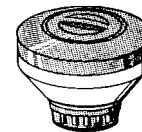

EROSION FEEDERS

RAINBOW #320C In-line chemical feeder (use 1" or 3" tabs)

320C	01K075452	2" or 1½" piping, rated to 35,000 @3ppm	\$116.07
------	-----------	---	----------

RAINBOW #300C Off-line chemical feeder

300C	01K071408	Installation tubing/clamp kit for PVC 24,000 gals @ 3PPM	\$109.84
------	-----------	---	----------



Custom Molded Products erosion feeder with unions w / Stand

25280-400	01K099901	CMP Power-Clean in-line feeder	\$153.69
25280-300	02K083260	CMP Power-Clean off-line feeder	\$128.09

RAINBOW COMMERCIAL--1" Off-line hard plumbed chemical feeders

Use with 1" & 3" trichlor or bromine tabs.

HC3315	07K161158	#HC-3315 Adjustable flow to 97,600 gals @10 PPM	\$247.92
HC3330	19K176486	#HC-3330 Adjustable flow to 160,000gals @ 10 PPM	\$271.50
HC3340	08K184927	#HC-3340 Adjustable flow to 322,000 gals @10 PPM	\$284.49

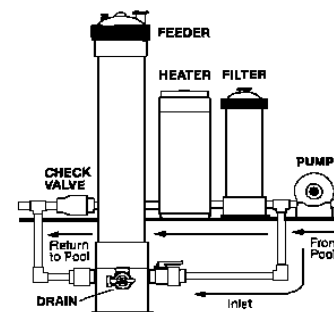

CHEMICAL FEED PUMPS

A1N10A-7T	14K03855	BLUE & WHITE ...peristaltic type 52.5 GPD, 50 PSI	\$550.00
A1N10S-7T	17KD3855	BLUE & WHITE ...peristaltic type low feed for 300-10,000 gallons 5.25 GPD	\$550.00
C15N402X	13K03137	BLUE & WHITE ...diaphragm type 68 GPD, 60 PSI	\$447.00
LE14SA-VHC1	15K04439	PULSAFEEDER ... diaphragm type for chlorine, 24 GPD, 100 PSI	\$633.00
LE14SA-VVC1	16K04503	PULSAFEEDER ...diaphragm type for acid, 24 GPD, 100 PSI	\$643.00

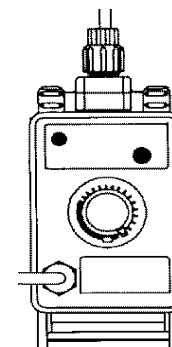
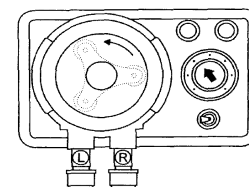

CHEMICAL SOLUTION TANKS

ST-50	12K002779	50 gallon with polyethylene cover	\$396.00
-------	-----------	-----------------------------------	----------

SECTION 5

SALT/CHLORINE SYSTEMS

AUTO PILOT® CHLORINE GENERATOR

COMMERCIAL and RESIDENTIAL APPLICATIONS

Auto Pool Pilot Features:

...**Automatic Temperature Compensation** : Automatically adjusts the output level setting based upon changes in seasonal water temperatures, between 50° to 90° F.

...**Dual Boost Modes**: Boost / Shock mode for 24 and 72 hours.



Power Supply / Cell Manifold Assemblies

94105/DIG220	78SG011851	DIG220 Power Supply 120/240V with SC-36 cell/manifold assy. for pools up to 20,000 gallons.	\$1,713.00
94107/DIG220	79SG013742	DIG220 Power Supply 120/240V with SC-48 cell/manifold assy. for pools up to 40,000 gallons.	\$1,985.00
94113/DIG220	80SG016053	DIG220 Power Supply 120/240V with SC-60 cell/manifold assy. For pools up to 50,000 gallons.	\$2,318.00

Replacement Residential Cells

SC-36	90SG04611	SC-36 Replacement Cell with Unions	\$614.00
SC-48	91SG06832	SC-48 Replacement Cell with Unions	\$911.00
SC-60	92SG09383	SC-60 Replacement Cell with Unions	\$1,250.00
CC-15	93SG14254	CC-15 Replacement Cell with Unions	\$1,900.00
9411SC/DIG220	96SG018541	DIG220 Power Supply 120/240V with CC-15 Commercial Cell	\$2,677.00

COMMERCIAL MANIFOLD ASSEMBLIES WITH CELL

Call ROGERS for commercial pool sizing. Because of swimmer load, temperature variance and pool size, the calculations are made using a program specifically designed for the more extreme pool use.

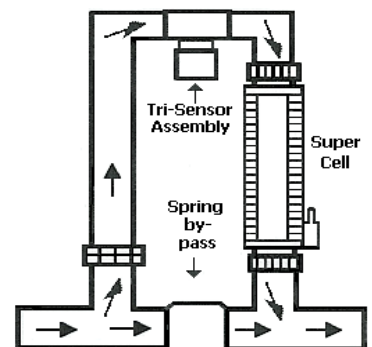

GS40	72KD10685	40# Bag Granular Pool Salt	\$15.26
------	-----------	----------------------------	---------

BENEFITS

- > Pool maintenance is now simplified
- > No more messy chlorine tabs
- > Soft, silky feeling water
- > No more red eyes...itchy skin...green hair
- > No vacation worries...it works without supervision
- > Energy efficient...low voltage to Super Cell
- > Improved water quality...the water glistens
- > Easily retrofits to existing pool or perfect for new pools



SECTION 5

SALT/CHLORINE SYSTEMS

ITEM NUMBER	CONTROL NUMBER	PRODUCT DESCRIPTION	PRICE
-------------	----------------	---------------------	-------

Pentair Intellichlor™ Chlorine Generator

- No more running out of chlorine...**NO MORE GREEN POOLS.**
- Convenience...save time by no longer having to transport handle, store or manually add chlorine to your pool
- Full diagnostic capabilities including tracking cell life
- Pays for itself by eliminating chlorine costs
- Push-button operation & easy-to-view displays
- Maintains chlorine levels 24 hours a day
- Helps eliminate eye irritation, dry skin and chlorine odor
- Easily retrofits to existing pool or perfect for new pools
- Pool water feels softer and silkier
- Absolutely safe...UL listed
- 24 Hour "Boost" cycle



Intellichlor™ In-Line Chlorine Generator

Controller panel, in-line cell assy. 15' UL cable & 2" unions

Required lbs of salt =
Pool gallons x 8.33 x .003

520554/56	66KD09681	IC-20 Up to 20,000 gallons, 120/240V	\$1,489.00
520555/56	67KD10602	IC-40 Up to 40,000 gallons, 120/240V	\$1,631.00
521105/56	68KD12483	IC-60 Up to 50,000 gallons, 120/240V	\$1,920.00

Replacement Intellichlor™ Cells

520554	69KD06024	IC-20 Replacement Cell only	\$926.00
520555	70KD06945	IC-40 Replacement Cell only	\$1,068.00
521105	71KD08826	IC-60 Replacement Cell only	\$1,357.00

POOL SALT Only certain salt can be used NaCl

GS40	72KD10681	40# Bag Granular Salt, must be 99% sodium chloride (NaCl). It cannot contain iodine or Yellow Prussia of Soda (causes staining)	\$15.26
------	-----------	---	---------

Replacement Parts for Polaris Autoclear & Autoclear Plus

82-760	79KD006744	In-line cell assy. w/flow switch (AutoClear)	\$898.00
82-760P	79KD006749	In-line cell assy. w/flow switch (Auto Plus)	\$898.00
82-534	81KD013726	System microphone	\$18.29
84-742	82KD142233	Flow Switch-AutoClear	\$189.64
84-742PC	83KD179840	Flow Switch-AutoClear Plus	\$239.78

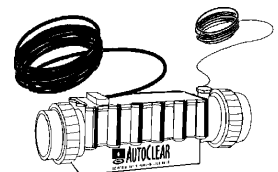

104A	76PT011674	4" Rd. Zinc Anode Wt. Designed to stop erosion and plaster discoloration due to electrolysis. Drops into skimmer bskt.	\$15.56
------	------------	--	---------

"Eco Select" is a trademark of Pentair Water Pool and Spa, Inc.

SECTION 5

OZONE SANITIZERS

ITEM NUMBER	CONTROL NUMBER	PRODUCT DESCRIPTION	PRICE
-------------	----------------	---------------------	-------



CORONA DISCHARGE (CD) or ULTRA VIOLET (UV)?

- * CD costs much less to operate
- * CD produces more grams of *ozone* than UV per hour
- * CD produces a higher concentration of *ozone than UV*

OZONE MAKES SENSE

- * Continually "shocks" pool
- * Breaks down chloramines
- * pH neutral
- * Makes water easier on body
- * Eliminates odors, bleaching effects and skin irritants
- * Improved water clarity
- * Reduces chemical usage



ECLIPSE--Spa CD Ozonator (May require injector manifold)

ECS-1	23U01101	ECS-1, Spa to 1000 gallons, 110 V	\$157.00
-------	----------	-----------------------------------	----------

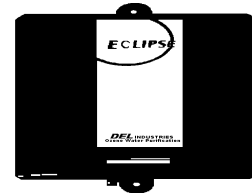

ECLIPSE--Pool CD Ozonator (IU-211 injector **not** included)

EC-1	24U03751	Pools up to 7,000 gallons	\$536.00
EC-2	25U05795	Pools up to 15,000 gallons	\$827.00
EC-4	26U08652	Pools up to 40,000 gallons	\$1,236.00

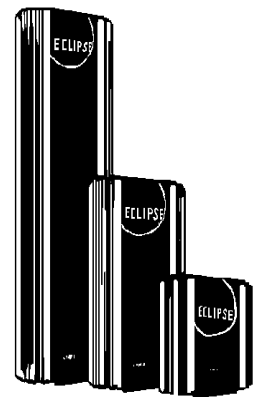

INJECTOR MANIFOLDS & ACCESSORIES

IU-211	07U01974	IU-211 universal injector for 1 spd	\$281.00
7-1140-01	08U05817	Tubing check valve 1/4"	\$7.75

OZONE LAMPS FOR DEL

9-0341	34OL069384	Lamp for ZO-910/ 912, wire leads	\$92.50
9-0341A	35OL000906	Lamp for ZO-901/ 912, 4 pin	\$120.00

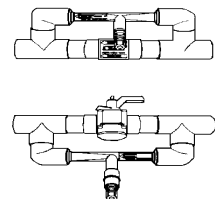

SECTION 6

HANDICAP ACCESSORIES

ITEM NUMBER	CONTROL NUMBER	PRODUCT DESCRIPTION	PRICE
-------------	----------------	---------------------	-------

RANGER LIFT™ by Aqua Creek

F-411RPL	1AC036590	RANGER LIFT™ (anchors not included)	\$4,065.00
F-433PP4A8A	2AC188201	8" Single anchor Insert (4- required)	\$98.00

FEATURES :

ADA COMPLIANT ---- RECHARGEABLE BATTERY OPERATION
 300 lb. WEIGHT CAPACITY---- 2yr. WARRANTY----
 AFFORDABLE SOLUTION FOR SMALLER INDOOR AND
 OUTDOOR POOLS.

SPA LIFT™ by Aqua Creek

F-006PSLB	3AC049462	THE PRO SPA LIFT 40 LIFT™	\$5,495.00
-----------	-----------	---------------------------	------------

FEATURES :

ADA COMPLIANT----400lb WEIGHT CAPACITY----360° ROTATION
 LIMITED LIFETIME WARRANTY----S/S CONSTRUCTION
 DESIGNED TO PROVIDE ACCESS TO BOTH SPAS & A/G POOLS

PAL LIFT™ by S.R. SMITH

200-0000	4SR064343	PAL LIFT™ (Portable Aquatic Lift)	\$7,149.00
----------	-----------	-------------------------------------	------------

FEATURES :

ADA COMPLIANT----300 lb WEIGHT CAPACITY----240° ROTATION
 COMPLETELY PORTABLE----24 V RECHARGEABLE BATTERY
 SINCE 1997 THE PAL HAS BECOME THE INDUSTRY STANDARD IN
 PROVIDING ACCESS TO SWIMMING POOLS.

aXs LIFT™ by S.R. SMITH

AXS1000	5SR042504	aXs LIFT™ (Semi- Permanent)	\$4,722.00
---------	-----------	-------------------------------	------------

FEATURES :

ADA COMPLIANT---- 300 lb WEIGHT CAPACITY----360° ROTATION
 SEMI - PERMANENT INSTALLATION----EASILY REMOVABLE ANCHOR
 THE aXs LIFT IS PERFECT WHERE IT'S LOW PROFILE AND
 ATTRACTIVE APPEARANCE MAKES POOL ACCESS EASY.

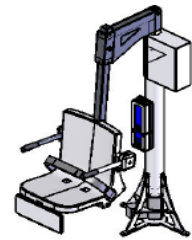

ALL CHAIR LIFTS ARE F.O.B. SHIPPING POINT



Other models also available

Compliance by March 15, 2012

**ADA
COMPLIANT**

SECTION 8

DECK EQUIPMENT

ITEM NUMBER	CONTROL NUMBER	PRODUCT DESCRIPTION	PRICE
-------------	----------------	---------------------	-------

STAINLESS STEEL LADDERS

Residential & Light Commercial Pools

RLF24S-2A	01L222489	2 Tread, .049" wall, 1.9" O.D.	\$317.83
RLF24S-3B	02L238177	3 Tread, .049" wall, 1.9" O.D.	\$340.24
RLF24S-4C	03L337096	4 Tread, .049" wall, 1.9" O.D.	\$481.56

Commercial Pools

LF24-2A	09L436552	2 Tread, .065" wall, 1.9" O.D.	\$623.64
LF24-3B	04L515752	3 Tread, .065" wall, 1.9" O.D.	\$736.79
LF24-4C	05L586551	4 Tread, .065" wall, 1.9" O.D.	\$837.93

Heavier gauge stainless steel available upon request

HANDRAILS & GRABRAILS

2HR-4	08L0116315	48" Handrail, .049" wall	\$166.16
2HR-5	09L0128098	60" Handrail, .049" wall	\$182.99
2HR-6	56L0153389	72" Handrail, .049" wall	\$219.11
DMS-101A	11L0108382	48" Deck Mount Rail, .049" wall	\$154.83
F4H-102	13L0083432	Single Grabrail, .049" wall	\$119.19

Heavier gauge stainless steel available upon request

DECK ANCHORS & ESCUTCHEONS

3019B	01A011555	Brass Anchor, 3" single	\$16.50
4019BC	02A016512	Brass Anchor, 4" single	\$23.59
PC3020B	05A031126	Brass Channel Anchor Kit, 20" x 3"	\$44.46
PC3008B	06A029837	Brass Channel Anchor Kit, 8" x 3"	\$42.61

Game / Stanchion anchor

AS-100D	68T038510	6" bronze anchor w/cover plate	\$55.01
PEO19S	07A004069	Escutcheon, stainless steel, round	\$6.25

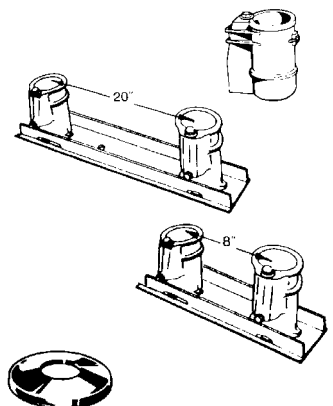
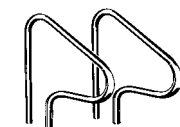
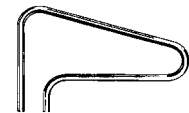
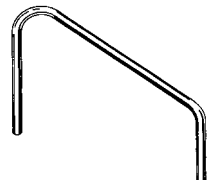
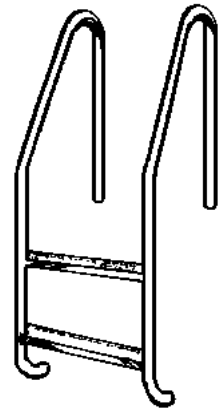

SECTION 8

DECK EQUIPMENT

ITEM NUMBER	CONTROL NUMBER	PRODUCT DESCRIPTION	PRICE
LADDER ACCESSORIES			
LTDF-103	08A024976	Ladder Tread, stainless, 3" x 20" o.c.	\$35.67
A42077-0	09A024979	Ladder Tread, Cicolac 4" x 20" o.c.	\$35.67
LTDF-101	49A009981	Ladder Tread, Cicolac, 17-1/4" Econoline	\$14.26
41494	03A024257	Brass Wedge Assy (Frost to 1990), each	\$34.64
PW	04A003672	Brass Wedge Assy for 3019BC, each	\$5.24
PW-4C	05A004641	Brass Wedge Assy for 4019BC, each	\$6.63
WRB101A	11A003403	Ladder Bumper, Female	\$5.23
WRB100A	12A002028	Ladder Bumper, Male	\$3.11
40909-1	10A011236	Tread Nut & Bolt Kit (standard)	\$16.04
60-703	22A010912	Tread Nut & Bolt Kit (for LTDF-101 tread)	\$15.59
CMP25578.000	54A032757	Recessed Step, white (set of 3)	\$46.79

SLIDES

ROGUE™ GRAND RAPIDS™

6' 6" tall, scratch resistant acrylic construction

Color Choices: white & marine blue

Other slide colors available: Taupe & Pewter Grey **add 15%**

R1530-RB	01S016261	Curve Right or Left ROGUE™ slide	\$2,168.00
75-209-586	03S039583	Flange Anchor w/hardware (Plastic)	\$52.77
PF25SGL	04S009988	Flange Anchor only (Plastic)	\$13.31
75-209-5000	05S021087	3" Aluminum Surface Deck Anchor	\$28.11
69-209-041	06S035662	Slide Tubing Repair Kit	\$47.55

ROCKETRIDE™

Created to fit virtually any size in-ground pool

4'-6" tall, low profile, compact design in 4 designer colors

Color Choices : white, marine blue, pewter grey & taupe

622-209-58XX	06S016930	Curve Rt. or Lt. ROCKETRIDE™ slide	\$2,257.00
--------------	-----------	---	------------



SECTION 8

DECK EQUIPMENT

ITEM NUMBER	CONTROL NUMBER	PRODUCT DESCRIPTION	PRICE
-------------	----------------	---------------------	-------

DIVING BOARDS

Frontier III—Intended for Residential Moderate to Heavy Use

596-2	01D03355	6' Solid Wood Core, Flex sides	\$515.00
598-2	02D04449	8' Solid Wood Core, Flex sides	\$683.00
600-2	03D05467	10' Solid Wood Core, Flex sides	\$840.00



Frontier III Plus for Commercial use

610-2	08D07639	10' Solid Wood Core, Flex Sides	\$1,174.00
612-2	09D09988	12' Solid Wood Core, Flex Sides	\$1,535.00
614-2	10D18291	14' Solid Wood Core, Flex Sides	\$2,814.00
616-2	11D19845	16' Solid Wood Core, Flex Sides	\$3,052.00

Eureka Competitive for Commercial use

244-2	12D25646	14' Solid Wood Core	\$3,945.00
246-2	13D28299	16' Solid Wood Core	\$4,352.00

Olympian Aluminum Competitive Commercial use

308-2	14D13555	8' Welded Beam Construction	\$2,085.00
310-2	15D15864	10' Welded Beam Construction	\$2,440.00
312-2	16D19700	12' Welded Beam Construction	\$3,031.00
314-2	17D30402	14' Welded Beam Construction	\$4,677.00
316-2	18D33023	16' Welded Beam Construction	\$5,080.00



DIVING ACCESSORIES

UF18-101	04D108386	18" Dive Stand, U-frame, S/S	\$154.83
67-209-911-ss	08A043498	Board Mounting bolt kit, 4½" x ½"	\$62.13
TDP100	05D088429	Board Mounting bolt Kit, 5½" x ½", S/S	\$126.31
FC-100A	06D027111	20" Rubber Fulcrum Cover	\$38.73
KEL-F120	07D050233	Dive Board Refinish Kit (white)	\$71.75

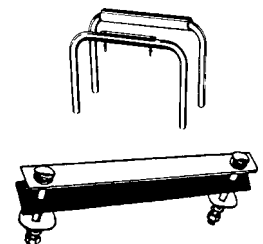

FLEX TREAD -Non skid board covering

R1539-80	01DA05445	18" wide, per lineal foot	\$7.25
R1539-860	02DA02967	18" wide x 60' roll, white	\$395.00
PC-98T	03DA04134	Edge sealer, 4 oz, clear (Perma-Seal)	\$5.50

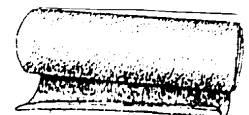

SECTION 8

DECK EQUIPMENT

ITEM NUMBER	CONTROL NUMBER	PRODUCT DESCRIPTION	PRICE
-------------	----------------	---------------------	-------

DIVING STANDS

Flyte-deck Dive Stand---Fiberglass

736-2	25D02997	6' Dive Base for 6' Board	\$460.00
738-2	26D03218	8' Dive Base for 8' Board	\$494.00
740-2	27D04054	10' Dive Base for 10' Board	\$623.00



Cantilever Steel Jump Stands

606	54DS04598	Stand/jig & spring for 6' Board	\$706.00
608	55DS05554	Stand/jig & spring for 8' Board	\$854.00



Steel Dive Stand Base

209-501	21D11796	½ Meter Base for 8' Board	\$1,814.00
209-502	22D11913	½ Meter Base for 10' Board	\$1,832.00

Steel Dive Stand Handrails

209-550	23D09008	Pair Handrails for 8' Dive Stand	\$1,385.00
209-551	24D09343	Pair Handrails for 10' Dive Stand	\$1,437.00

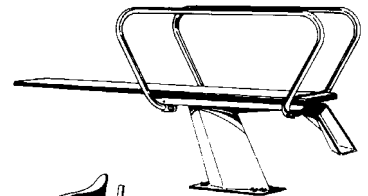

LIFEGUARD STANDS

LG101	01G22904	Cantilever Style , flanged steel column in red oxide primer, fiberglass footboard & chair, stainless handrails, flanged column bolts for anchor/base.	\$3,053.00
ILGS-205	02G16125	Institutional , stainless seat support umbrella holder, fiberglass footboard & seat, stainless steel frame and step treads.	\$2,149.00
PLS-204	21F26339	Portable Style , stainless frame, seat and umbrella holder, fiberglass footboard with non-skid surface.	\$3,511.00

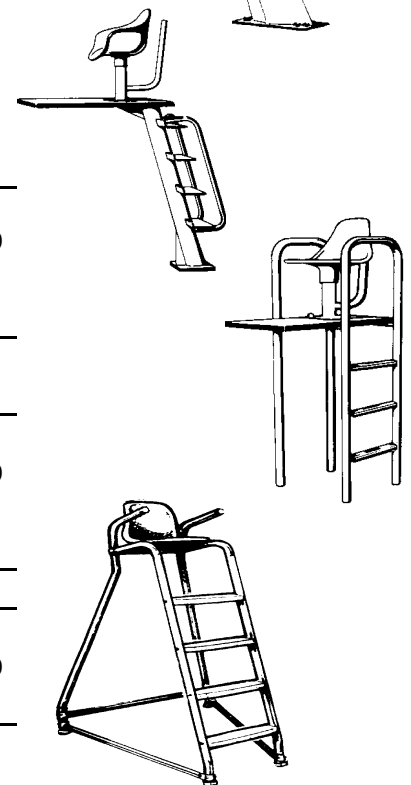

SECTION 9

WHITE GOODS

ITEM NUMBER	CONTROL NUMBER	PRODUCT DESCRIPTION	PRICE
-------------	----------------	---------------------	-------

SKIMMERS

PRE-FAB/VINYL WALLS

506420	02SK115714	Bermuda, standard 1½" slip ports	\$165.30
506521	03SK130181	Bermuda WideMouth, 1½" thrd ports	\$185.93
25540-000-000	57SK007282	Std. Faceplate cover (fits Hay. & CMP)	\$9.71
25541-000-000	56SK017784	W/M faceplate cover (fits Hay. & CMP)	\$23.70



50-6420



50-6521



50-6361

GUNITE/CONCRETE

506361	13SK078100	Bermuda Gunite, 2" slip ports	\$111.57
25248-000	45SV035291	Front Access 1½" spa skimmer	\$50.41

SKIMMER EXTENSION COLLARS

516253	09SK013764	Bermuda 2½" lid seat / deck collar	\$18.34
516259	48SK017216	Bermuda 4" lid seat / deck collar	\$22.95

SKIMMER LIDS With thermometer

SKWTH	74ST43956	American Prod, Hayward or Pentair	\$58.60
-------	-----------	-----------------------------------	---------



SKIMMER LIDS

SP1082E	28SK011585	Hayward SP1082E, square (25538-000)	\$15.44
850074	29SK015449	American Products--Admiral	\$20.58
516215	31SK015596	Pentair--Bermuda	\$20.78
8650-58	98SK013647	SwimQuip--U-3	\$18.19



SKIMMER BASKETS

P287	26SK029143	Clayton & Lambert (old style)	\$38.85
38012	22SK007791	Hayward SP1082CA	\$10.38
38010	23SK006885	Hayward SP1096CA	\$9.17
38013A	24SK013947	American Products #850001	\$18.59
38008	25SK006159	SQ #8650-7 & B-9	\$8.20



SKIMMER WEIRS

P1082K	20SK012233	Hayward SP1082K	\$16.30
P280	19SK021682	Clayton & Lambert, old style 4 bolt	\$28.90
516252	21SK012754	Pentair--Bermuda	\$17.00
38013B	17SK009772	American Products, round #850012	\$13.02
8650-22	18SK015194	SwimQuip, hinged #8650-22	\$20.25

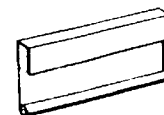

RETURNS & VACUUM FITTINGS

PRE-FAB/VINYL WALLS

862051	10F009408	1½" threaded for Vinyl liner	\$13.43
542411	87F008472	1½" socket, long body w/ nut, pre-fab	\$12.10

CONCRETE/GUNITITE

542402	41F003587	Long Body, 1½" socket	\$5.11
542423	11F005143	2" Insider, fits inside 2" PVC sch. 40, accepts standard eyeball (25524-200)	\$7.34

DIRECTIONAL INSERTS, GRATES & PLUGS

540021	02F002569	"Eyeball Insert", 1½" Thrd x ¾" opening	\$3.66
540056	03F001515	Insert grate, 1½" Thrd.	\$2.16
552622	05F001579	1½" Thrd plug w/ o-ring	\$2.24
540042	06F002558	1 1/2" Insider eyeball assy.	\$3.64

MAIN DRAINS

RESIDENTIAL FOR VINYL-with Anti-Entrapment Cover

25515-700	03MD035266	2" side/bottom, 2-1½" bushing & plug	\$50.37
-----------	------------	--------------------------------------	---------

RESIDENTIAL FOR CONCRETE-with Anti-Entrapment Cover

25513-700	01MD033186	2" side/bottom, 2-1½" bushing & plug	\$47.40
-----------	------------	--------------------------------------	---------

ANTI-ENTRAPMENT MAIN DRAIN FRAME & GRATE COVERS

These new swimming pool frames and grates comply with ASME/ANSI A112.19.8-2007 as it relates to the "Virginia Graeme Baker Safety Act"

25507-100-010	07CMP11571	8" Round VGB Safety Cover (White)	\$16.53
640-4700V	09W0057833	9" x 9" Sq. Main Drain Frame & Grate	\$82.61
640-4720V	07MD078639	12" x 12", Main Drain Safety Cover opening of 62.4 sq. inches allowing for a flow of 292 GPM at a velocity of 1½ feet per second	\$112.33
640-4750V	08W002929	18" x 18" Sq. VGB Safety Cover & Frame	\$417.00
640-4760V	09W358190	24" X 24" Sq. VGB Safety Cover & Frame	\$511.70

MAIN DRAIN ACCESSORIES

600-2100	08MD011507	Hydro-static relief valve 2" / 1½"	\$16.43
SP1055	09MD009539	Collection Tube 1½" / 2"	\$13.61



SECTION 9

WHITE GOODS

ITEM NUMBER	CONTROL NUMBER	PRODUCT DESCRIPTION	PRICE
-------------	----------------	---------------------	-------

HYDRO-THERAPY

Scalloped Design available in white, Gray, Tan & Black

25594-150	46CM022933	Spa Master™ Directional Jet 1/12" x 1" 10 gpm, 2½" Hole size, White	\$32.76
25591-230	47CM036432	Pulsator Style, 11/2" x 1" 10 gpm	\$52.04
25591-250	48CM036431	Twin Spin Style, 11/2" x 1" 10 gpm	\$52.04
25591-240	49CM038130	Massage Style, 11/2" x 1" 10 gpm	\$54.47
23308-000-100	50CM020031	Gunite Venturi tee, extended Jet Assy. 17-20 GPM	\$28.61



SUCTION FITTINGS

VGB Compliant Suction Fittings

25201-200	51CM027878	2" slip, white, 3 5/16" hole size 170 gpm	\$39.81
25215-000	52CM024209	2" slip, white, 3" hole size 190 gpm	\$34.57



AIR CONTROLS

25098-000-000	53CM012602	Top Draw Air Control, white, 1" slip	\$17.99
---------------	------------	--------------------------------------	---------



SPA SKIMMERS

25245-000-000	54CM018431	Spa Strip surface type, 1½" slip	\$26.33
---------------	------------	----------------------------------	---------



AUTOMATIC WATER FILL

T40F	55LT0080159	LETRO filler w/ Fluidmaster valve	\$123.30
T40B	56LT0080153	LETRO filler w/ brass float valve	\$123.30
T26	57LT0031867	Brass valve replacement	\$42.48
T29	58LT0019343	Fluid Master valve replacement	\$25.78

T-27 Brass Valve
Replacement for MP Autofill

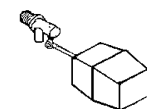

FILL SPOUTS

41240	01FS078456	1" Stainless, MPT	\$112.07
41242	02FS109824	1½" Stainless, MPT	\$156.89

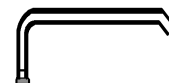

SECTION 10

LIGHTING

ITEM NUMBER	CONTROL NUMBER	PRODUCT DESCRIPTION	PRICE
LIGHT BULBS			
400R/40/FL	01LB015958	400w/120v, reflector, medium base	\$21.27
400G/FL	02LB018609	400w/120v, globe type, medium base	\$24.80
100R/FL	04LB011502	100w/120v, Reflector, medium base	\$15.33
25A/Par 56	02LB024481	300w/12v, seal beam, (2) screw terminal	\$32.64
21AR/40/FL	07LB018981	300w/12v, reflector, medium base	\$25.31

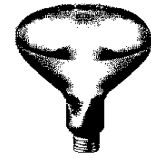

Reflector



G-Globe



HALOGEN BULBS

Q100T/3,	30HB012065	100W/12V, 2 pin, (791312 AmerQuartz)	\$16.08
100Q/CL/MC	31HB012409	100W/ 120V, MiniCan, (SR0011 & 791029)	\$16.53
250Q/CL/DC	32HB012401	250W/120V, Dbl contact (SR0015 & 791127)	\$16.53
250Q/CL/MC	33HB012404	250W/120V, MiniCan, (SR0014 & 791138)	\$16.53
250Q/T3/CL	34HB012067	250W/120V, RSC, (788811 AquaLumin)	\$16.08
840211	35HB119218	150W Metal Halide Bulb (fiber-optic)	\$158.95
235001000	36HB052299	19.7V Quartz Bulb (fiber-optic)	\$69.71
79112400	37HB016520	75W Quartz Bulb (Sam Light)	\$22.03

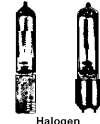

Halogen

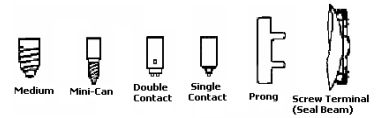

LIGHTING ACCESSORIES

791001	01LA019701	Lens, 8 3/8", Hayward & Am. Products	\$26.26
5055-0003	18LA052343	Lens, 10 hole Swimquip	\$69.79
5057-0118	01LA030147	Lens gasket, 10 hole (SwimQuip)	\$40.18
SP503W	02LA019888	Lens gasket , 8-3/8" dia. (Hay.)	\$26.50
791016	03LA019369	Lens gasket, 8-3/8" dia. (Am. Prod.)	\$25.81
789001	04LA045672	8-3/8" Lens Cover Kit, 4 colors	\$60.89
132	05LA010581	Light retainer wedge kit	\$15.11
500C	03LA091065	Adapter light ring, chrome	\$121.41
500P	56LA042280	Adapter light ring, plastic	\$56.37
ST300-12	13L129092	12V, Transformer, up to 300 watt	\$184.41



LENS KIT

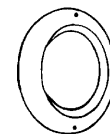

LIGHT RING

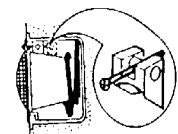

LIGHT WEDGE

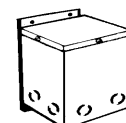

ITEM NUMBER	CONTROL NUMBER	PRODUCT DESCRIPTION	PRICE
-------------	----------------	---------------------	-------

POOL & SPA LIGHTS

AMERLITE---Underwater Lights with stainless steel face rings

78441100	02L0172076	400w/120v, 15' cord	\$245.81
78448100	03L0203977	400w/120v, 50' cord	\$291.39
78949100	04L0251988	400w/120v, 100' cord	\$359.97
78438100	05L0231579	300w/12v, 50' cord	\$330.81



AQUA-LIGHT & SPA BRITE---Underwater Lights

77168100	07L0177307	250w/120v, 50' Aqua-Light (Halogen)	\$253.29
78106000	08L0153878	60w/120v, 30' Spa Brite (Halogen)	\$219.81
78106100	09L0171529	60w/12v, 50' Spa Brite (Halogen)	\$245.03



HAYWARD---12 Volt "Old" Shallow Niche Application (SP502)

SP502-50	85HL455004	300W, 12V Seal Beam Type, 50' cord	\$699.00
----------	------------	------------------------------------	----------

STA-RITE---10 Hole Lens Style Light

05086-0050	74L0227723	500W, 120V, 50' Cord	\$350.33
------------	------------	----------------------	----------



LIGHT NICHE'S

AMERLITE---Stainless Steel---3/4" Rear Hub

78232400	05L126853	Niche for Vinyl/pre-fab	\$181.21
78210700	06L059453	Niche for Concrete	\$84.93

AQUA-LIGHT & SPA BRITE---Stainless Steel

78242200	09L0073023	Niche for vinyl for pre-fab	\$104.31
78244200	10L0048054	Niche for concrete	\$68.64



LED COLOR CHANGING LIGHTS

IntelliBrite® Color LED---Automated Pool Lighting

600110	02L0652001	IntelliBrite® 120V, 30' cord	\$931.00
600111	03L0668002	IntelliBrite® 120V, 50' cord	\$954.00
600114	04L0604003	IntelliBrite® 12V, 30' cord	\$863.00

IntelliBrite® Color LED---Automated Spa Lighting

640050	05L0522004	IntelliBrite® 120V, 30' cord	\$746.00
640053	06L0494005	IntelliBrite® 12V, 30' Cord	\$706.00

600054	07L0220006	IntelliBrite® Controller (<i>multiple lights</i>)	\$314.00
--------	------------	---	----------

THE IntelliBrite® Light :

- * Fits or adapts to most light niches
- * 5 fixed colors
- * 7 color shows
- * Superior reflector



SECTION 10

FIBER OPTIC LIGHTING

ITEM NUMBER	CONTROL NUMBER	PRODUCT DESCRIPTION	PRICE
-------------	----------------	---------------------	-------

FIBERWORKS

METAL HALIDE GENERATOR

840241	22FW692892	7 color, manual switch, auto control compatible	\$923.85
840242	56W869014	7 color, synchronized, manual switch, auto control compatible, electronic sync	\$1,158.68
840262	91FW025146	90% Window dimmer	\$33.52



COMPLETE LENS ASSEMBLIES--- Vinyl, pre-fab or gunite

22000100	40FW043449	Gunite invisible, 1" socket	\$57.92
22000200	46FW043449	Gunite standard, 1" socket	\$57.92
22000400	41FW043445	Vinyl, white, 1½" FPT	\$57.92
22000500	42FW043441	Fiberglass/pre-fab, white 1½" slip	\$57.92

LENS SUB ASSEMBLY without housing

22102000	38W038233	Complete lens assembly w/o housing	\$50.97
----------	-----------	------------------------------------	---------

ULTRA GLO-- Perimeter fiber optic cable

21003600	61W0409192	UltraGlow 25, 150' cable	\$545.59
21003700	62W0545272	UltraGlow 25, 200' cable	\$727.03
21007600	70W0921095	UltraGlow 50, 150' cable	\$1,228.12
21007700	71W1227534	UltraGlow 50, 200' cable	\$1,636.71

TRACK FOR ULTRA GLO CABLE

21004200	80W0142402	"C" Track for gunite or FG, 104 ft	\$189.87
21005100	90W0185157	"L" Track for vinyl, 104' (13 x 8')	\$246.87

SEE PAGE 27 FOR FIBER OPTIC CABLE

PHOTON GENERATOR:

- * 600 Fiber capacity
- * 7 colors plus white
- * Available with remote control & color synchronization
- * Includes subterranean mounting base
- * Use for pool perimeter, pool & spa lighting and landscape lighting

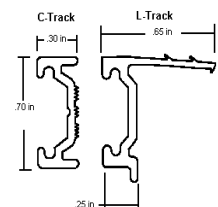

SECTION 10

FIBER OPTIC LIGHTING

ITEM NUMBER	CONTROL NUMBER	PRODUCT DESCRIPTION	PRICE
-------------	----------------	---------------------	-------

AMERGLO FIBER OPTIC CABLE KITS

Kits are pre-cut & cable is OpiFused to lens

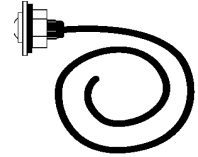

840077	11FW0591233	325 fiber strand, 20 ft. kit	\$788.31
840078	12FW1303503	Roll 325 strand x 50'	\$1,738.00
20211800	21FW0479571	225 fiber strand, 20 ft. kit	\$639.43
21001300	13FW0963847	Roll 225 stand x 50'	\$1,285.12
20210500	70W0251717	170 fiber strand, 14 ft. kit	\$335.61
20210700	71W0297676	170 fiber strand, 17 ft. kit	\$396.89
20210900	31FW0345296	170 fiber strand, 20 ft. kit	\$460.09
21001000	14FW0655949	Roll 170 strand x 50'	\$887.92
840103	72W0157598	100 fiber strand, 16 ft. kit	\$210.12
840105	40W0231741	100 fiber strand, 25 ft. kit	\$308.99
840099	15W0405098	Roll 100 strand x 50'	\$540.12
20215600	20FW0208569	70 fiber strand, 25 ft. kit	\$278.08
21001500	16FW0356862	Roll 70 strand x 50'	\$475.81
840152	30W0164744	50 fiber strand, 25 ft. kit	\$219.65
840154	17W0266495	Roll 50 strand x 50'	\$355.32

There are many variables involved in properly designing a fiber optic installation.

Give us a drawing with details:

1. Pool & deck size
2. House location
3. Pool interior surface color
4. Light generator should be **NO** more than 10' from pool

REMEMBER: This is mood & accent lighting. If safety is an issue, standard pool lights should also be installed.

NOTES :

For additional information: www.pentairpool.com

SECTION 12

SAFETY

ITEM NUMBER	CONTROL NUMBER	PRODUCT DESCRIPTION	PRICE
-------------	----------------	---------------------	-------

ROPE HOOKS

PH52	01RH007825	Rope Hooks, 1/2" clamp type	\$11.17
PH53	02RH008499	Rope Hooks, 3/4" clamp type	\$12.13

ROPE ANCHORS

PI77	04RA010187	Eyebolt type for pre-fab, CPB	\$14.54
PI70	05RA005622	External type, CPB (pair)	\$8.03
PI72	06RA009099	Eyebolt type for vinyl, CPB	\$12.99
25568	07RA006651	Plastic Rope Anchor with S.S. Pin	\$9.50

41141	01RA078456	Cup type for concrete, CPB	\$112.07
41144	02RA164022	Flush type for concrete, CPB	\$234.31
40022	03RA027914	Eyebolt only, 1/2" threads, CPB	\$39.87

ROPE FLOATS

3X5-BW	01RF001269	Float, 3" x 5" blue & white	\$1.93
5X9-BW	02RF002497	Float, 5" x 9" blue & white	\$3.83

FLOAT KEEPERS...One float requires 4 "halves" & 2 screws

R71	05RF003710	5 x 9 on 3/4" rope (181436)	\$5.70
-----	------------	-----------------------------	--------

SAFETY LINE KITS---Rope, floats & single hook kit

R181226	20RK018607	16' Safety line kit	\$28.61
R181216	21RK023051	18' Safety line kit	\$35.46
R181206	22RK027339	20' Safety line kit	\$42.07
R6017	23RK004785	CPB Rope hook	\$7.35

POOL ROPE

PR25-6	01RP00081	1/4" rope, per foot	\$0.10
PR50-6	03RP00320	1/2" rope, per foot	\$0.43
PR75-3	05RP00622	3/4" rope, per foot	\$0.82

EMERGENCY EQUIPMENT

153 LF	08SE012837	Life Hook, aluminum (#153)	\$19.73
820-12	02VA018112	12' Straight Handle	\$27.86
4715	09SE053756	First Aid Kit , 24 unit	\$71.67

REP102	10SE259001	Spine Board with Straps	\$370.00
REP401	24SE018905	Strap kit for Spine Board	\$26.99

734	15SE130006	Universal Head Immobilizer	\$173.00
710	16SE085008	Rescue Tube, 50" long x 6" x 4"	\$113.33

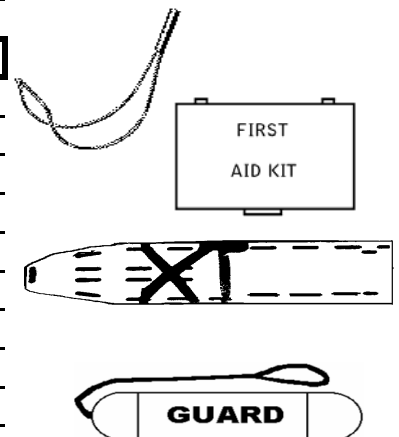
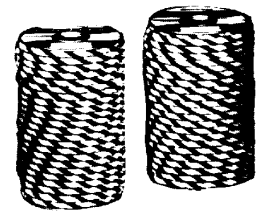
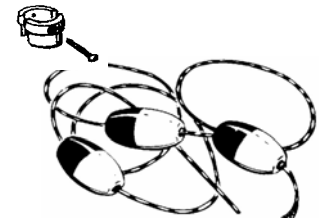
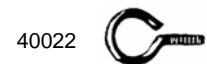
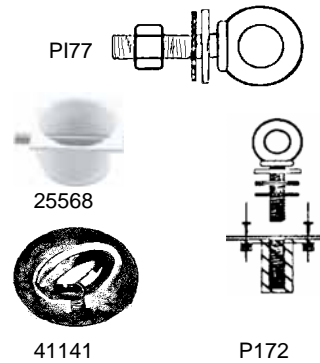
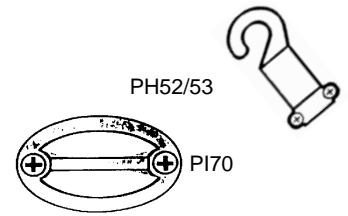

SECTION 12

SIGNS and SAFETY

ITEM NUMBER	CONTROL NUMBER	PRODUCT DESCRIPTION	PRICE
-------------	----------------	---------------------	-------

LIFE RINGS & THROW LINES

CJ-G20	03SE051319	20" USCG approved Life Ring	\$68.41
CJ-G24	04SE056775	24" USCG approved Life Ring	\$75.69
CJ-G30	05SE066891	30" USCG approved Life Ring	\$89.19
CJ-P20	01SE025891	20" Plastic life ring (P20)	\$34.52
803	07SE008784	Metal life ring hanger (#803)	\$11.70
724	06SE012317	60' x 1/4" Throw Line	\$16.41

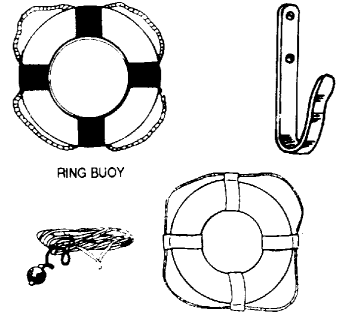

POOL & SPA SIGNS

234000	02PS020867	Hotel/Apt Pool Rules	24" x 36"	\$27.81
230900	03PS007131	Pool Capacity	18" x 12"	\$9.51
231200	04PS007139	No Diving	18" x 12"	\$9.51
230500	13PS012283	No Lifeguard on Duty	24" x 18"	\$16.07
23850	21PS037569	DANGER HAZARDOUS CHEMICALS	18" x 24"	\$49.99
231400	35PS003726	Pool Closed	12" x 6"	\$4.96

POOL RULES	
1.	All persons using pool do so at their own risk. Owners and management are not responsible for accidents or injuries.
2.	Pool is for private use only. Guests must have management permission.
3.	No animals allowed.
4.	No drinks or food permitted in pool.
5.	Running or unnecessary noise is not permitted at any time.
6.	After using pool, footwear and towels must be used when returning to building.
7.	Persons with long hair must wear bathing cap.
8.	Management reserves the right to deny use of pool to anyone at any time.
HOURS	_____ to _____

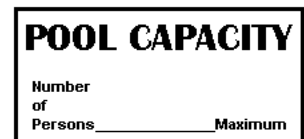

ITEM NUMBER	CONTROL NUMBER	PRODUCT DESCRIPTION	PRICE
-------------	----------------	---------------------	-------

DEPTH MARKERS

4" BLACK VINYL---Self-Adhesive non-skid surface

DM-1-#	01DM002351	Single number, specify number	\$3.13
DM- ½	02DM002352	1/2"---Fractional number	\$3.13
DMFT-IN	03DM004085	"FT" or "IN" marker (per set only)	\$5.44
PS-4WC	22PP004133	"Clear" Permanent Sealer, 4 oz	\$5.50

0 1 2 3 4 FT
5 6 7 8 9 IN

INLAYS, INC---6" X 6" Vinyl stick-on **OR** Ceramic, black on white 4" letters, *smooth or skid-resistant*

DM-FT-6	05DM006673	"Number" w/ "FT", single or double digit	\$8.89
DM-IN-6	06DM006670	"Number" w/ "IN", single or double digit	\$8.89
MG-6	11DM006674	Message tile, black print	\$8.89
MG-6BR	07DM008008	Message tile, black/red print	\$10.67

3^{FT} **3^{1/2}**

6^{IN} **7^{IN}** **8^{IN}**



INLAYS, INC---8" x 8" Vinyl stick-on **OR** Ceramic, black on white 6" letters, *smooth or skid-resistant*

DM-FT-8	08DM012253	"Number" w/ "FT", single or double digit	\$16.33
DM-IN-8	09DM012250	"Number" w/ "IN", single or double digit	\$16.33
MG-8	12DM012258	Message tile, black print	\$16.33
MG-8BR	10DM013588	Message tile, black/red print	\$18.11

3^{FT} **3^{1/2}**



CHILD SAFETY ALARMS

SAFETY TURTLE-----Child protection. Child wears a colorful *Turtle* on their wrist.
If he or she falls into the water, a loud alarm sounds at the base station.

B102	55SF147462	Base station (AC-powered) Place w/in100 feet of pool. Any number of <i>Turtles</i> can be used with (1) base.	\$196.61
T101	56SF062089	Turtle wrist band Colors: Green, blue, yellow, red, purple	\$82.77

TURTLE POWER

- * 10 Hour battery life
- * Low battery warning
- * Charge from AC or 12 VDC power source

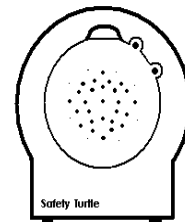

THERMOMETERS

B136	01TH008783	E-Z Read Combo thermometer #136 Floats or submerges on rope leash	\$13.50
B127	02TH006278	Economy Pool Thermometer #127	\$9.65

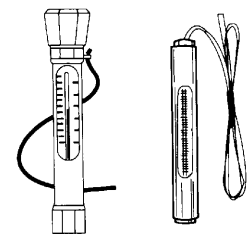

SECTION 14

POOL MAINTENANCE

ITEM NUMBER	CONTROL NUMBER	PRODUCT DESCRIPTION	PRICE
LETRO LEGEND <i>Residential Booster Pump Cleaner</i>			
105C	01LL07413	Legend Sweep w/ booster pump and complete hose kit	\$988.00
LAOIN	02LL03049	Booster pump only, 115V/230V	\$405.00
LL505G	03LL05615	Legend Sweep w/ complete hose kit * (less booster pump)	\$748.00



AQUA PRODUCTS

Residential Fully Automatic Pool Cleaners

- > On-Board Filtration System
- > 24 Volt Operating System
- > Fully Automatic-"Plug & Play"
- > Cleans Any Size, Shape or Type of Pool
- > Climbs and Cleans Pool Sidewalls
- > Scrubs Hard to Remove Dirt
- > Removable & Re-usable Filter Bag
- > Lightweight & Easy to Use

AB2040	11AP10774	Aquabot	\$1,436.00
AT2050	12AP12336	Aquabot Turbo with 7 hour timer	\$1,644.00
AT2550	13AP19309	Aquabot Turbo T4RC with 7 hr timer & remote	\$2,573.00

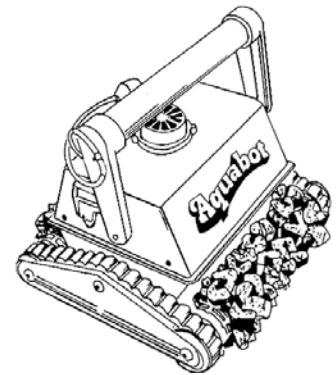

Product Name	Pool size	Cleaning Coverage	Cord	Timer
Aquabot	Up to 20 x 40	3500 Sq. Ft. per Hour	51' w/ buoys	No
Aquabot Turbo	Up to 20 x 50	6500 Sq. Ft. per Hour	60' Floater	Yes
Aquabot Turbo Remote	Up to 25 x 50	6800 Sq. Ft. per Hour	75' Floater	Yes

Filtration specifications: 2 micron reusable polyester felt/fine mesh self-contained bag

Drive Motor: DC hi-speed brushless, oil-filled, submersible

Pump Motor: AC 2 phase brushless, oil filled, submersible

Voltage in Water: 24 volts



SECTION 14

POOL MAINTENANCE

ITEM NUMBER	CONTROL NUMBER	PRODUCT DESCRIPTION	PRICE
-------------	----------------	---------------------	-------

AQUA PRODUCTS
Commercial Automatic Pool Cleaners

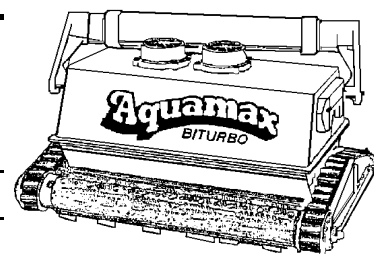

AMJ45	14AP013357	Aquamax Junior HT 17.5" wide	\$1,483.00
AJP60	15AP019042	Aquamax Junior Plus 17.5" wide	\$2,116.00
AMX75	16AP026151	Aquamax, 21" wide	\$2,905.00
AMBT75	17AP041544	Aquamax BiTurbo, 21" wide	\$4,616.00
UMXJ80	18AP053223	Ultramax Jr, 21" wide	\$5,913.00
UMX80	19AP064115	Ultramax, 30" wide	\$7,123.00
AQK200	20AP003738	UltraKart 200, for wide body commercial	\$414.00

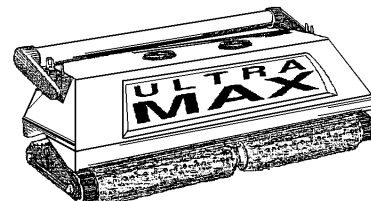

Product Name	Pool size	Cleaning Coverage	Cord	Wall/Floor
Aquamax Junior HT	Up to 45 ft.	4800 Sq. Ft. per Hour	60'	50% wall 50% floor
Aquamax Jr. Plus	Up to 60 ft.	5500 Sq. Ft. per Hour	100'	50% wall 50% floor
Aquamax	45' to 75'	7500 Sq. Ft. per Hour	120'	10% wall 90% floor
Aquamax BiTurbo	over 75'	7500 Sq. Ft. per Hour	120'	10% wall 90% floor
Aquamax BiTurbo R/C	over 75'	7500 Sq. Ft. per Hour	120'	10% wall 90% floor
Ultramax Jr.	Up to 80'	8500 Sq. Ft. per Hour	120'	10% wall 90% floor
Ultramax	over 80'	12,500 Sq. Ft. per Hour	120'	10% wall 90% floor

Operating Volts: 24 Volts

Filtration specifications: 2 micron reusable polyester felt/fine mesh, self-contained bag

Drive Motor: DC high-speed brushless, oil-filled, submersible

Pump Motor: AC 2 phase brushless, oil-filled, submersible

Optional add-ons:

For :

R10556	21AP10556	Radio Remote Control..... Available on Aquamax Plus Jr. and BiTurbo	\$1,172.00	Ultramax Aquamax Aquamax Aquamax
R2953	22AP02953	Infrared..Makes unit floor cleaning only	\$328.00	
R2209	23AP07732	Infrared.. Makes unit floor cleaning only	\$859.00	
R1905	24AP01905	Air Sensor.. For "zero depth" pools and handicap ramps. Keeps unit from walking out of pool	\$211.00	
R2827	25AP02827	Solo option...For any wall climbing Aquamax units. Converts unit to floor cleaner without expense of infrared .	\$313.00	

SECTION 14

POOL MAINTENANCE

ITEM NUMBER	CONTROL NUMBER	PRODUCT DESCRIPTION	PRICE
-------------	----------------	---------------------	-------

POLES & ACCESSORIES

191306	01VA021335	8'-16', 2 Pc.Telescoping Handle	\$32.81
191088	03VA041616	12'-24', 2 Pc.Telescoping Handle	\$64.02
191106	02VA018102	12' Straight Handle	\$27.84
191296	04VA005462	Pole Lock Nut # 806	\$7.28
221036	05VA003043	Plastic Hangers, 2-hook, (145)	\$4.68
12P	12VA007106	Metal 2-hook Hanger (Nycon)	\$10.92
R-SSB	07VA003935	Handle bolt & wing nut set	\$5.24

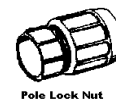

Pole Lock Nut

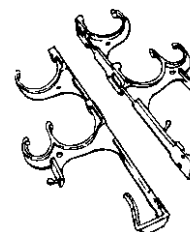

VACUUMING EQUIPMENT

VACUUM HEADS

201388	09V021757	Flex-Vac, 14" wide (203)	\$33.46
201126	10V075985	Flex-Vac, 19" wide (250)	\$101.30
201112	58V033738	Deluxe #188 Flex Vac (188)	\$51.89
201398	12V035828	"Clear View" w/brushes (196)	\$55.10
201350	13V020094	Vac head w/brushes (193)	\$30.90

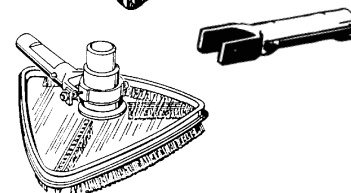
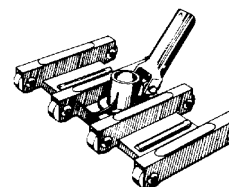

VACUUM HEAD PARTS

201526	14VP06349	Brush set for R193 vac (193R)	\$8.45
201540	15VP07058	Brush set for R 196 vac (196R)	\$9.40
201556	16VP01972	Handle spring clip, pkg. of 3 (170)	\$2.63
201486	18VP02965	Handle, replacement (192)	\$3.94
201426	19VP02244	Wheel set of 4, for FlexVac (174)	\$2.98
201466	20VP03753	Axle set of 4, for FlexVac (178)	\$5.00

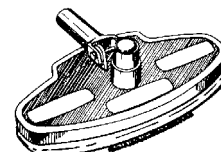

SPA WAND by Polaris

5-100-00	02SL045535	Spa Wand, simple vac for pool & spa	\$65.04
----------	------------	-------------------------------------	---------

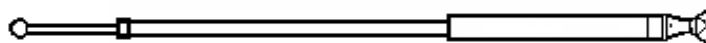

ABOVE GROUND POOL AND/OR SPA VACUUM KIT

201146	21V024486	Mini-Vac w/bag & 6' handle (204)	\$37.66
--------	-----------	------------------------------------	---------

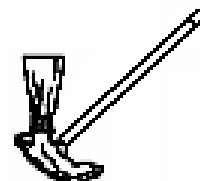

LEAF TRAP & ACCESSORIES

211084	06VA059441	#186 "Snap-Open" Leaf Trap, see-thru, large handle for carrying, bag & 3' hose	\$91.44
211516	07VA008019	Replacement mesh bag	\$10.68
211518	08VA015841	Silt bag	\$21.12
27182-020-000	09VA031822	Basket (rigid plastic)	\$42.43

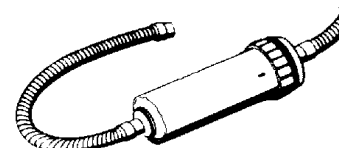

SECTION 14

POOL MAINTENANCE

ITEM NUMBER	CONTROL NUMBER	PRODUCT DESCRIPTION	PRICE
-------------	----------------	---------------------	-------

LEAF EATER

211036	10VA031332	Leaf Eater, wheels & brush included	\$44.76
211426	12VA008947	Replacement bag, regular mesh	\$11.92
211286	13VA012755	Replacement bag, fine mesh	\$17.00

VACUUM HOSE

HELIX VAC HOSE 1½" & 2"

HLX-30	04VH038239	30' x 1½" Vac Hose	\$57.05
HLX-35	05VH044623	35' x 1½" Vac Hose	\$66.60
HLX-40	06VH050988	40' x 1½" Vac Hose	\$76.09
HLX-50	07VH063726	50' x 1½" Vac Hose	\$95.10
HELIX-50	02VH121487	50' x 2" Vac Hose	\$181.24

FORGE LOOP VAC HOSE 1½"

FL-25	08VH024581	25' x 1½" Vac Hose	\$36.69
FL-30	09VH029493	30' x 1½" Vac Hose	\$44.01
FL-35	10VH034429	35' x 1½" Vac Hose	\$51.37
FL-40	11VH039338	40' x 1½" Vac Hose	\$58.70
FL-50	12VH049169	50' x 1½" Vac Hose	\$73.37

FORGE LOOP VAC HOSE 1¼"

FL-24AG	13VH019339	24' x 1¼" Vac Hose	\$28.85
FL-30AG	14VH024165	30' x 1¼" Vac Hose	\$36.06
FL-36AG	15VH028981	36' x 1¼" Vac Hose	\$43.25

PUMP/POOL CUFFED CONNECTING HOSE

R1249-3	20VH008307	1½" x 3' Cuffed Hose	\$12.38
R1249-6	21VH012666	1½" x 6' Cuffed Hose	\$18.90
R1248-3	22VH007442	1¼" x 3' Cuffed Hose	\$11.10
R1248-6	23VH010995	1¼" x 6' Cuffed Hose	\$16.40

VACUUM ACCESSORIES

51-0166	01HC01136	Cyclac 1½" vacuum adapter	\$1.50
772008	03HC02580	Vac Hose End Cuff 1½"	\$3.44
765803	04HC03988	Vac Hose End Cuff 1½" w/ swivel	\$5.31
772874	05HC03986	Vac Hose End Cuff 2"	\$5.31
SP1104-1	27VH09153	Vac Plate, 1½" x 1¼", elbow, Hayward	\$13.07
SP1105-4	28VH12176	Vac Plate, 1½" x 1¼", straight, Hayward	\$17.39
SP1106	29VH11957	Vac Plate, 1½" x 1½", straight, Hayward	\$17.07
850019	30VH08618	Vac Plate, American Products	\$11.48
50-6161	31VH13986	Vac Plate, Pentair	\$18.64

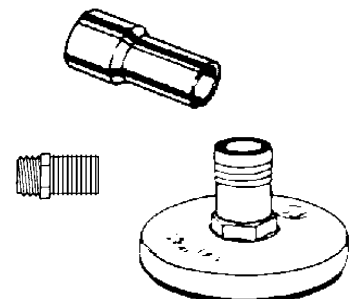
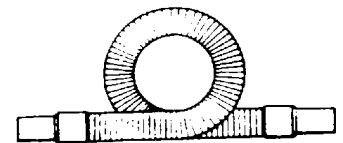
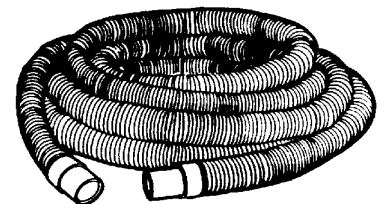
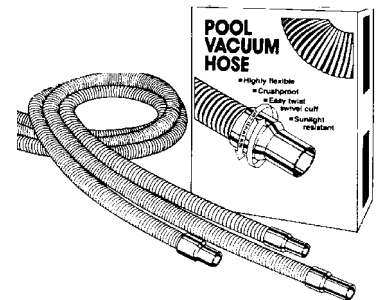
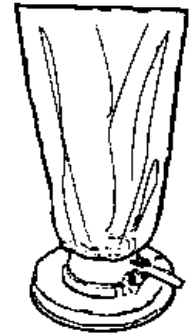

SECTION 14

POOL MAINTENANCE

ITEM NUMBER	CONTROL NUMBER	PRODUCT DESCRIPTION	PRICE
-------------	----------------	---------------------	-------

BACKWASH HOSE

859-1½ C	26PV000387	1½" See-thru blue, per foot	\$0.54
859-1½ R	27VP067868	1½" x 200' coil See-thru blue	\$96.94
877-2C	28VP000453	2" See-thru blue, per foot	\$0.64
877-2R	29VP080987	2" x 200' coil See-thru blue	\$115.69



POOL-TILE SCRUBBER

8000/930	30AB016151	Mr. Scrubber w/ light duty pad (white)	\$24.85
8031	31AB003082	Light Duty (white) Repl. Scrub Pad	\$4.74
8033	32AB003233	Medium Duty (blue) Repl. Scrub Pad	\$4.97
7031/621R	33AB001924	Duo Scub Pad 4" x 6"	\$2.95

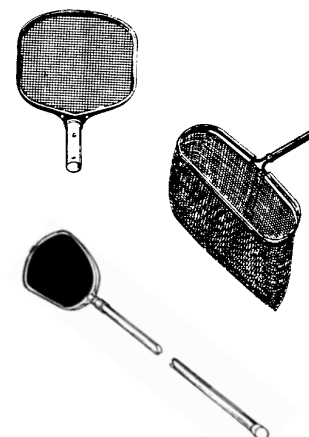

LEAF NETS & RAKES

121026	15VA007969	Economy Leaf Skimmer (119)	\$12.24
121230	15VA018754	22" PRO Leaf Rake (117)	\$28.84
121186	16VA008721	Hand leaf skimmer on 4' handle 124H	\$13.41
121106	20VA015361	22" Deep Net Rake (122)	\$23.63
420N	18VA025076	20" Deep Net Rake	\$38.56
830N	19VA040843	30" Deep Net Rake	\$62.83

POOL BRUSHES

111046	01PB011359	Deluxe 18" Curve	\$17.46
111342	03PB019864	Deluxe 24" Curve	\$30.55
111366	05PB006325	Economy 18" Curve	\$9.72
111616	06PB009937	Algae Brush 6", S/S bristles	\$15.27
111626	07PB012386	Algae Brush 9", S/S bristles	\$19.04
111646	08PB020415	Algae Brush 18", S/S bristles	\$31.40
9600/9004H	68AB016846	Acid /Tile Brush w/60" Thrd. Handle	\$25.91
9600	69AB011927	Dual-sided Acid Brush only	\$18.34
9004H	70AB004928	60" Thrd. Wooden Handle	\$7.57

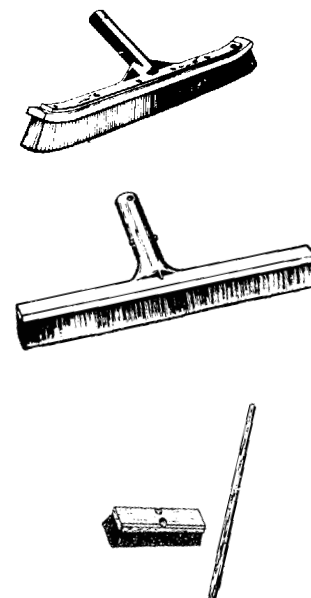

SECTION 16

SAND FILTERS

ITEM NUMBER	CONTROL NUMBER	PRODUCT DESCRIPTION	PRICE
-------------	----------------	---------------------	-------

PENTAIR FILTERS

SAND DOLLAR

- * One-piece blow-molded tank
- * 35# maximum operating pressure

145320	01F0274006	SD40, 19.5" w/6 position top mt. Valve, internals (Requires 150# sand)	\$409.00
145322	02F0310003	SD60, 22.5" w/6 position top mt. Valve, internals (Requires 200# sand)	\$463.00
145333	03F0337004	SD80, 26" w/ 6 position top mt. Valve, internals (Requires 350# sand)	\$503.00



SAND DOLLAR

TAGELUS

- * 50# maximum operating pressure
- * Plastic top valve clamp

144127	02F0379003	TA50, 22" w/6 position top mt. valve, internals (Requires 225# sand)	\$541.00
145241	03F0411004	TA60, 24" w/ 6 position top mt. valve, internals (Requires 325# sand)	\$587.00
145240	04F0637005	TA100D, 30" w/ 2" 6 position top mt. valve, internals (Requires 600# sand)	\$910.00



TAGELUS

SAND FILTER VALVES

26-1050	21F0121433	Side Mount 2" Slip ports (Hi-Flo)	\$181.23
26-1055	57F0148094	Side Mount 2" Thrd. Ports (SM20-3)	\$221.03
26-1173	20F0093005	Side Mount 1 1/2" Thrd. ports (SM10-3)	\$138.81
26-2506	75F0096276	Top Mount 1 1/2" Thrd. Ports (TA)	\$143.69
261185	76F0152457	Top Mount 2" Thrd. Ports (TA 100D)	\$227.54
SPO714-T	77F0100542	Top Mount 1 1/2" Thrd. Ports (Hay.)	\$150.06



GAUGES

ILPG6025-4L	21V0011342	Glycerin Filled, 0-60# pressure	\$15.12
ILPG602-4L	12PV004804	Pressure Gauge, 0-60#	\$6.40
IPVG302-4B	13PV035176	Vacuum Gauge, 0-30"/Hg	\$6.89



FILTER MEDIA --- Sand & DE

10050-S	01FA09501	50# Bag Silica Sand (.45-.55 mm)	\$12.67
10050-P	02FA09503	50# Bag Pea gravel (1/8" X 1/4")	\$12.67
DE-50	23DE53004	50# Bag Diatomaceous earth	\$70.67



SECTION 16

SAND FILTERS

ITEM NUMBER	CONTROL NUMBER	PRODUCT DESCRIPTION	PRICE
-------------	----------------	---------------------	-------

TRITON® II SAND FILTERS

Residential & Light Commercial

(Select side mount dial valve from list on page 36)

140264	14F05023	TR-60, 24" Tank & internals only 3.14 SF filter area (100# pea / 250# fine)	\$717.00
140210	15F07364	TR100, 30" Tank & internals only 4.91 SF filter area (150# pea / 450# fine)	\$1,051.00
140243	16F10785	TR140, 36" Tank & internals only 7.06 SF filter area (300# pea / 700# fine)	\$1,540.00



TRITON® C and TRITON® C-3 SAND FILTERS

Commercial

(Select side mount dial valve from list on page 36)

140315	45F07793	TR100C, 30" Tank & internals only, 4.91 SF, 8" dome opening, 2" drain	\$1,113.00 * plus freight
140316	46F11547	TR140C, 36" Tank & internals only, 7.06 SF, 8" dome opening, 2" drain	\$1,649.00 * plus freight

* Triton C & C-3 filters are F.O.B. factory

Triton C-3 features standard 3" flange connections. Flow valving is field plumbed.

140310	47F09815	TR100C-3, 30" Tank & internals only, 4.91 SF, 8" dome opening, 2" drain	\$1,399.00 * plus freight
140342	48F13771	TR140C-3, 36" Tank & internals only, 7.06 SF, 8" dome opening, 2" drain	\$1,967.00 * plus freight

* Triton C & C-3 filters are F.O.B. factory



Jacuzzi Replacement Sand Filter Dial Valves

TM-22-H8	68F125581	2DVK-C7, 2"- 7 way valve (SandStorm)	\$187.43
TM12-JL	55F090708	DVK-7, 1½" 7 way w/unions (Laser- bolt-on)	\$135.37
TM-12-H8	84F090707	DVK-7C, 1½", w/unions (Laser Clamp-on)	\$135.37



SECTION 16

CARTRIDGE FILTERS

ITEM NUMBER	CONTROL NUMBER	PRODUCT DESCRIPTION	PRICE
-------------	----------------	---------------------	-------

CLEAN and CLEAR by Pentair

- * Fiberglass reinforced polypropylene tank
- * Ring-Lok access to filter element for easy servicing
- * Safety tab lock assures safe operation
- * 2" threaded ports
- * Anchor kit included to secure tank to pad

160315	56CF02967	CNC 75, 75 sq.ft. Cartridge filter	\$442.00
160316	02CF03753	CNC100, 100 sq. ft. Cartridge filter	\$560.00
160317	04CF04975	CNC150, 150 sq. ft. Cartridge filter	\$742.00
160318	14CF05821	CNC200, 200 sq. ft. Cartridge filter	\$869.00



CLEAN and CLEAR PLUS by Pentair

- * Four extra large filter cartridges for extra long filter cycles before cleaning
- * 2" threaded ports

160340	06CF07269	CNCP320, 320 sq.ft Cartridge filter	\$1,117.00
160301	21CF08249	CNCP420, 420 sq.ft Cartridge filter	\$1,268.00
160332	23CF10209	CNCP520, 520 sq.ft Cartridge filter	\$1,569.00

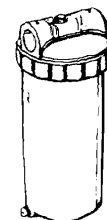

RAINBOW IN-LINE

RDC25	05CF075889	Model RDC25, 25 sq. ft. area	\$108.40
RDC50	65CF090836	Model RDC50, 50 sq. ft. area	\$129.76

SCAMP PORTABLE VAC SYSTEM

AL725	01H14405	SCAMP "See-Thru" #725, Mounted on Stainless Steel Cart and fitted with a 75 SF Cartridge Filter, 3/4 HP (full-rated) pump, 3' cord with 15 amp GFI.	\$2,057.00
-------	----------	---	------------

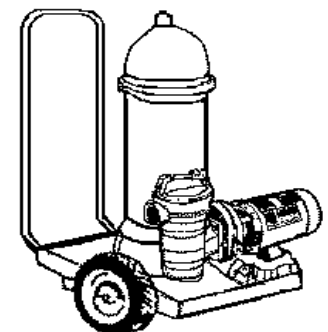

SECTION 16

REPLACEMENT CARTRIDGES

ITEM NUMBER	CONTROL NUMBER	PRODUCT DESCRIPTION	PRICE
-------------	----------------	---------------------	-------

REPLACEMENT CARTRIDGE FILTERS

C9650	03CA045309	JACUZZI CFR50.....50 sq ft,	\$60.40
C9699	05CA080627	JACUZZI CFR100...100 sq ft,	\$107.49

C9481	41JC099601	JACUZZI SHER120...120 sq ft,	\$132.80
C9482	42JC108604	JACUZZI SHER160...160 sq ft,	\$144.80

C9410	78PC074169	PENTAIR CC100, 100 sq ft (R173215)	\$98.80
C9415	79PC097702	PENTAIR CC150, 150 sq ft (R173216)	\$130.26
C9419	78PC121949	PENTAIR CC200, 200 sq ft (R173217)	\$162.58

C4625	08CA022243	RAINBOW RDC25...25 sq ft,	\$29.65
C4950	26CA027402	RAINBOW RDC50...50 sq ft,	\$36.53

SR70	14CA058285	STA-RITE, 70 sq ft	\$77.71
SR100	15CA076588	STA-RITE, 100 sq ft	\$102.11
SR135	16CA095929	STA-RITE, 135 sq ft	\$127.89

0203S	31SR425164	STA-RITE S8M150, Modular, (outer)	\$566.88
0202S	32SR261328	STA-RITE S8M150, Modular, (inner)	\$348.43

0201S	34SR313586	STA-RITE S7M120, Modular, (outer)	\$418.11
0200S	33SR137803	STA-RITE S7M120, Modular, (inner)	\$210.40

C4320	19CA022795	HAYWARD, C200RE	\$30.39
C4325	20CA026997	HAYWARD, C225RE	\$35.98

C7626	21CA034803	HAYWARD, C250RE	\$46.40
C7656	38CA052138	HAYWARD, C500RE	\$69.51

R136-06	17CA005351	HARMSCO 6 sq ft, 1-24	\$7.13
R136-0628	18CA004901	HARMSCO 6 sq ft, 24 +	\$6.53

ST155C	25CA125743	HARMSCO ST155	\$167.65
ST105C	26CA095146	HARMSCO ST 105	\$126.85

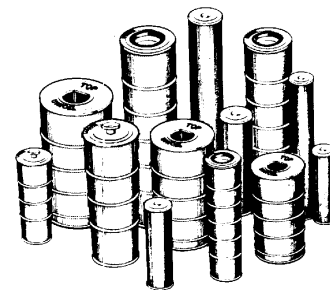

START UP PRESSURE + 8 to 10 PSI

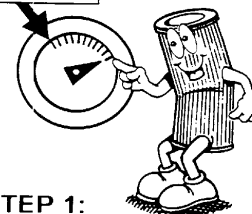

STEP 1:

Clear the cartridge when the filter canister pressure reaches a maximum of 8 - 10 PSI above the initial system or new cartridge starting pressure.

SECTION 16

FLOW METERS

ITEM NUMBER	CONTROL NUMBER	PRODUCT DESCRIPTION	PRICE
BLUE & WHITE- --Top Mount			
Price includes stainless steel mounting clamps.			
F30100P	41FM082359	1" Pipe, 5-40 GPM	\$109.80
F30150P	01FM082358	1½" Pipe, 20-100 GPM	\$109.80
F30200P	02FM088421	2" Pipe, 40-150 GPM	\$117.89
F30250P	03FM100677	2½" Pipe, 60-240 GPM	\$134.23
F30300P	04FM103833	3" Pipe, 80-300 GPM	\$138.44
F30400P	05FM113134	4" Pipe, 125-500 GPM	\$150.84
F30600P	06FM182108	6" Pipe, 175-900 GPM	\$242.80
F30800P	07FM202289	8" Pipe, 300-1600 GPM	\$269.71



SECTION 17

SPECIAL PURPOSE PUMPS

SUBMERSIBLE & SUMP PUMPS

577301	01PF186237	Automatic Submersible pump, 1800 GPH, 1/3 HP, 25' Power Cord, Garden hose adapter, 3-yr. Warranty	\$248.31
574027	02PF122760	Pool Cover Pump Kit, 325 GPH, 18' Cord, 25' ½" tubing, garden hose adapter (#PCPK)	\$163.33



REPLACEMENT SPA PUMPS

AQUA-FLO...Flo-Master "FMCP" 2-Speed Spa Pumps
Less Strainer Housing...with Center Discharge, 1½" Ports

FMCP7	08A02939	¾ HP, 115V (AF #02607000)	\$419.00
FMCP1	09A03281	1 HP, 115V (AF #02610000)	\$469.00
FMCP15	09A04709	1½ HP, 115V (AF #02615000)	\$671.00

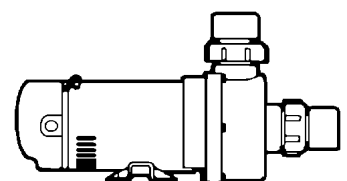

SECTION 17

PENTAIR PUMPS

ITEM NUMBER	CONTROL NUMBER	PRODUCT DESCRIPTION	PRICE
-------------	----------------	---------------------	-------

SUPERFLO PUMPS

- * Direct replacement for Hayward ® *Super Pump*
- * Unionized fittings-1-1/2 & 2" slip
- * Integral volute and pot to reduce noise



340036	01JC03495	SUPERFLO, ½ HP, 115/230 volts	\$521.00
340037	02JC03749	SUPERFLO, ¾ HP, 115/230 volts	\$558.00
340038	03JC04081	SUPERFLO, 1 HP, 115/230 volts	\$609.00
340039	04JC04402	SUPERFLO, 1½ HP, 115/230 volts	\$657.00
340040	05JC05109	SUPERFLO, 2 HP, 115/230 volts	\$761.00

OPTIFLO PUMP

- * 1-1/2" Ports
- * Large strainer basket with see-thru lid
- * Unionized discharge port connection
- * Easy to service
- * User-friendly removable drain plugs



347984	29JC02296	OPTIFLO, ¾ HP, 115V with 3' cord	\$342.00
347985	11JC02534	OPTIFLO, 1 HP, 115V with 3' cord	\$378.00
347986	12JC02837	OPTIFLO, 1½ HP, 115V with 3' cord	\$422.00

PENTAIR WHISPERFLO PUMPS

Whisper Quiet...Full Service Factor...2" x 2" Ports

11578	45PF04641	½ HP, 115/230V, #WF-2	\$663.00
11579	01PF05079	¾ HP, 115/230V, #WF-3	\$724.00
11580	02PF05338	1 HP, 115/230V, #WF-4	\$761.00
11581	03PF05797	1½ HP, 115/230V, #WF-6	\$827.00
11582	04PF06818	2 HP, 230V, #WF-8	\$973.00
11583	05PF08775	3 HP, 230V, #WF-12	\$1,253.00



Whisper Quiet...2-Speed...Full Service Factor...2" x 2" Ports

11486	91PF07329	1 HP, 2 speed, 230V # WFDS-4	\$1,046.00
11522	92PF07516	1½ HP, 2 speed, 230V # WFDS-6	\$1,073.00
11523	93PF08741	2 HP, 2 speed, 230V # WFDS-8	\$1,249.00



SECTION 17 ANTI-BODY ENTRAPMENT PUMPS

ITEM NUMBER	CONTROL NUMBER	PRODUCT DESCRIPTION	PRICE
-------------	----------------	---------------------	-------

IntelliFlo™ VS+SVRS

Intelligent Variable Speed Pump + Safety Vacuum Release System

- * Meets ASME A112.19.17.2002 Standards
- * Onboard intelligence detects blockage and automatically shuts pump off within seconds
- * Exclusive breakthrough motor technology provides energy savings while being safety compliant
- * SVRS protection cannot be turned off
- * Safety lock-out feature (password protected) prevents pump speed settings from being changed by unauthorized personnel
- * NSF certified and UL and ETL Listed
- * 8 settable, changeable speeds ranging from 1100 to 3450 RPMs
- * No SVRS calibration required; the blockage detection/shut down function is pre-programmed
- * If the SVRS becomes disabled, the pump will not run



11017	09VS013697	VS + SVRS pump (1/2 hp up to 3hp)	\$1,825.00
-------	------------	------------------------------------	------------

A.O. SMITH **GUARDIAN®** SVRS Motors

Safety Vacuum Release System-----SVRS

- * Meets ASME A112.19.17.2002 Standards
- * Full body entrapment release protection
- * Motors available up to 3 HP
- * **Also** provides protection against extreme voltage variation, jammed impeller or blocked/dirty filter

Easy Installation:

- * Installs just like a standard pool motor
- * Self calibrates, no field calibration
- * Achieve a better pump system by simply replacing the motor

BG128	51AOS05964	Guardian® SVRS, 1 HP 115/230 volts 56J frame, threaded shaft	\$851.00
BG129	52AOS07353	Guardian® SVRS, 1½ HP 115/230 volt 56J frame, threaded shaft	\$1,050.00
BG130	53AOS08521	Guardian® SVRS, 2 HP 230 volt 56J frame, threaded shaft	\$1,217.00
BG131	53AOS11501	Guardian® SVRS, 3 HP 230 volt 56J frame, threaded shaft	\$1,643.00
USQG1072	56AO005255	Guardian® SVRS 3/4 HP 115/230 volt 48 Y frame, sq. flange, threaded shaft	\$749.00
BG848	53AOS6471	Guardian® SVRS, 1 HP 115/230 volts 56Y frame, sq. flange, threaded shaft	\$924.00
BG854	54AOS6476	Guardian® SVRS, 1½ HP 115/230 volt 56Y frame, sq. flange, threaded shaft	\$924.00
BG748A	55AOS8760	Guardian® SVRS, 2 HP, 230 volts 56Y frame, sq. flange, threaded shaft	\$1,251.00
BG2844A	56AO10842	Guardian® SVRS, 3 HP 230 volts 56Y frame, sq. flange, threaded shaft	\$1,549.00



SECTION 17

COMMERCIAL PUMPS

ITEM NUMBER	CONTROL NUMBER	PRODUCT DESCRIPTION	PRICE
-------------	----------------	---------------------	-------

Stingl Safety Vacuum Release System

Designed and Built for Residential & Commercial Applications

- * Complies with ASME/ANSI 112.19.17
- * Works on New and Existing Pool & Spa Pumps
- * Easy Installation (No pipes to cut or glue)
- * Turns Off Pump in Milliseconds upon Detection
Sudden Vacuum Change
- * 30 Minute Maintenance Override



SR-500	01S06871	Solid State 120/240V 1/2 - 3 HP	\$916.00
SR-500PS	02S07742	Pool & Spa Combination Unit	\$1,032.00
SS-301-RS24	03S03753	Remote Alarm for SR-500 Units	\$499.00
E-STOP	04S01264	Emergency Stop Button for SR-500	\$168.00

STA-RITE--All Bronze Construction with 6" bronze strainer

Self-priming for residential & commercial pools and spas. Non-clogging semi-open face impeller, **2" suction x 1½" discharge**, NSF and UL listed

CF6EFL	06A11085	1½ HP, 230V, 1 phase	\$1,705.00
CF6EGL	07A11984	2 HP, 230V, 1 phase	\$1,843.00
CF6H	08A16295	3 HP, 230V, 1 phase	\$2,506.00



C/CC Series STA-RITE--All Bronze Construction with 6" bronze strainer

Commercial Pools & Spas. Includes NSF & UL listing, **2" suction & discharge**

CHH	01A020026	3 HP, 230V, 1 phase	\$2,860.00
CHH3	02A017749	3 HP, 230V, 3 phase	\$2,534.00
CHJ	03A020948	5 HP, 230V, 1 phase	\$2,991.00
CHJ 3	04A019101	5 HP, 230V, 3 phase	\$2,729.00

SECTION 17

PUMP MOTORS

ITEM NUMBER	CONTROL NUMBER	PRODUCT DESCRIPTION	PRICE
-------------	----------------	---------------------	-------

All Motors listed are single phase. Call for 3 phase pricing.

56J FRAME...Threaded Shaft...Full Service Factor

B126	07M02089	½ HP, 115/230V	\$297.00
B127	08M02335	¾ HP, 115/230V	\$333.00
B128	09M02440	1 HP, 115/230V	\$349.00
B129	10M03241	1½ HP, 115/230V	\$463.00
B130	11M03955	2 HP, 230V	\$564.00
B131	12M05342	3 HP, 230V	\$763.00



C-Face 56J

56J FRAME...2 Speed...Threaded Shaft...Full Service

B975	13M04038	1 HP, 230V	\$576.00
B977	14M04643	1½ HP, 230V	\$663.00
B979	15M05807	2 HP, 230V	\$829.00

48Y FRAME...Threaded Shaft...Up-Rated

BN24SS	16M01669	¾ HP, 115/230V	\$237.00
BN25SS	17M01822	1 HP, 115/230V	\$260.00
BN35SS	18M02156	1½ HP, 115/230V	\$307.00



Through Bolt Mount
48/56 Base Mtg.

48Y FRAME...Threaded Shaft...2-Speed...Up-rated

BN37	19M02163	1 HP, 115V, 2 speed	\$309.00
BN50	20M03027	1½ HP, 115V, 2-speed	\$431.00
BN51	21M03232	2 HP, 230V, 2-speed	\$461.00

48Y SQUARE FLANGE...Threaded Shaft...Full Service

QC1102	27M03741	1 HP 115/208/230V (Sta-Rite)	\$534.00
SQ1152	28M04362	1½ HP 230V (Sta-Rite)	\$623.00
SQ1202	29M05413	2 HP 230V (Sta-Rite)	\$773.00

56Y SQUARE FLANGE...Threaded Shaft...Full Service

B847	22M02987	¾ HP, 115/208/230V	\$426.00
B848	23M03465	1 HP, 115/208/230V	\$494.00
B858	24M04606	1½ HP, 115/208/230V	\$657.00
B748	25M05413	2 HP, 230V	\$773.00
B2844	26M06698	3 HP, 208/230V	\$956.00



Square Flange 56Y

SQUARE FLANGE...2-Speed...Threaded Shaft...Full Service

B2982	58M05317	1 HP, 230V, 2 speed	\$759.00
B2983	59M06386	1½ HP, 230V, 2-speed	\$911.00
B2984	60M07991	2 HP, 230V, 2-speed	\$1,141.00

SECTION 18

HEAT PUMPS

ITEM NUMBER	CONTROL NUMBER	PRODUCT DESCRIPTION	PRICE
-------------	----------------	---------------------	-------



Jandy AE-Ti Heat Pumps

with

Titanium Heat Exchanger

Not affected by unbalanced water chemistry

EE2000T	51HP33109	AE2000 110,000 BTU's / 4.6 COP @ 80° 61,000 BTU's / 3.0 COP @ 50°	40 amp breaker	\$4,940.00
EE2500T	52 HP37372	AE2500 120,000 BTU's / 4.6 COP @ 80° 76,000 BTU's / 3.0 COP @ 50°	50 amp breaker	\$5,577.00
EE3000T	53HP43666	AE3000T 140,000 BTU's / 4.6 COP @ 80° 90,000 BTU's / 3.0 COP @ 50°	50 amp breaker	\$6,517.00
EE3000T-R & Chiller	54HP50859	AE3000T-R w/Chiller 140,000 BTU's Heat @ 80° 90,000 BTU's Cool	50 amp breaker	\$7,589.00

Standard Features

- * Digital control panel displays pool temperature and monitors operating status of the unit
- * Titanium Heat Exchanger not affected by aggressive water chemistry
- * Commercial grade Scroll type compressor
- * *Auto Heat* maintains pool temperature 24 hours a day, overriding the pool time clock

FUEL TYPE	COST PER UNIT	BTU's / 1¢
Electric	.075 / Kwh	455
LP gas	.99 / Gal	653
Oil	.99 / Gal	979
Natural gas	.65 / therm	1077
HEAT PUMP	.075 /Kwh	2093



WHY A HEAT PUMP?

- * Uses heat in the air
- * Delivers \$4-\$7 of heat for each \$1 of energy used
- * 500%-600% efficient vs. 80-85% for gas heaters
- * Very little maintenance
- * No gas lines to run
- * No LP tanks to buy
- * 15-20 year life
- * Safer---NO GAS!
- * No pilot lighting
- * Clean emissions
- * Odorless operation

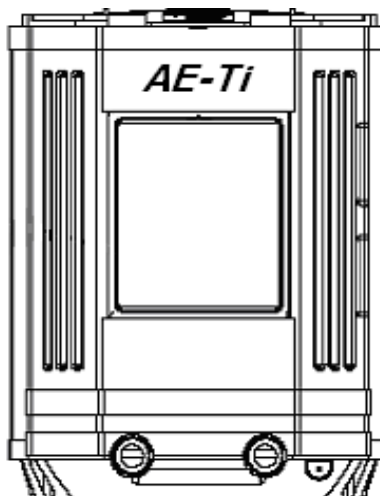

HOW DOES IT WORK?

- * Uses Nature's warm air to heat liquid freon and turn it into gas
- * Warm gas compressed into *hot* gas
- * Hot gas flows into the heat exchanger & releases heat to flowing water

SECTION 18

POOL & SPA HEATERS

ITEM NUMBER	CONTROL NUMBER	PRODUCT DESCRIPTION	PRICE
-------------	----------------	---------------------	-------

JANDY LEGACY Electronic Pilot Ignition..Nat or LP

LRZE125	14J11361	125,000 BTU, 2" connections	\$1,515.00
LRZE175	15J14262	175,000 BTU, 2" connections	\$1,901.00
LRZE250	16J16163	250,000 BTU, 2" connections	\$2,155.00
LRZE325	17J18394	325,000 BTU, 2" connections	\$2,452.00
LRZE400	18J20825	400,000 BTU, 2" connections	\$2,776.00
FOR ASME COMMERCIAL RATING ADD-ON (125K)			\$875.00
FOR ASME COMMERCIAL RATING ADD-ON (175K-400K)			\$675.00



JANDY LEGACY Millivolt Pilot Ignition...Nat or LP

LRZM125	01J10861	125,000 BTU, 2" connections	\$1,448.00
LRZM175	02J13792	175,000 BTU, 2" connections	\$1,839.00
LRZM250	03J15523	250,000 BTU, 2" connections	\$2,069.00
LRZM325	04J17884	325,000 BTU, 2" connections	\$2,384.00
LRZM400	05J20385	400,000 BTU, 2" connections	\$2,717.00



Controller Display



FOR ASME COMMERCIAL RATING ON LRZM SAME AS LRZE MODELS

JANDY "HI-E2" ---High Efficiency...Nat or LP

HI-E2-350	62H062848	350,000 BTU, Nat or LP	\$8,379.00
-----------	-----------	------------------------	------------

DRAFT HOODS...CAPS

DHVC5-9	08DH01108	Draft Hood for indoor installation or vent cap for outdoor. Specify heater size	\$147.00
---------	-----------	---	----------

HEAT SINKS

R1450	09HS039023	Stainless steel, 8" elbow with unions	\$52.03
-------	------------	---------------------------------------	---------

Hi-E2 Facts:

- * 95% Efficient
- * ASME rated
- * Electronic ignition
- * Direct vent w/PVC
- * Auto power venting
- * Bronze headers

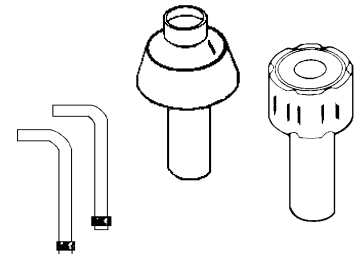

POOL HEATER

Model	125		175		250		325		400	
Temp Diff*	Maximum Area Heater (width x length)									
	0 Wind	3 1/2 MPH	0 Wind	3 1/2 MPH	0 Wind	3 1/2 MPH	0 Wind	3 1/2 MPH	0 Wind	3 1/2 MPH
15°F	875	675	1250	925	1775	1325	2300	1725	2850	2125
20°F	675	500	925	700	1325	1000	1725	1300	2125	1600
25°F	525	400	750	550	1075	800	1400	1050	1700	1300
30°F	450	325	625	475	900	700	1250	875	1425	1075
35°F	400	300	550	400	775	575	1000	750	1225	900

Natural Gas Pipe Size Requirements

Heater Size	Distance from Gas Meter		
	0-50 feet (0-15 m)	50-100 feet (15-30 m)	100-200 feet (30-60 m)
250	in.	in.	in.
400	1 - 1/4	1 - 1/2	1 - 1/2

SECTION 18

POOL & SPA HEATERS

ITEM NUMBER	CONTROL NUMBER	PRODUCT DESCRIPTION	PRICE
-------------	----------------	---------------------	-------

MASTER TEMP Pool and Spa Heater...Nat or LP **

Specify Type of Gas: Natural or LP

- * Fan assist vent
- * Long-life composite header system
- * Eco-friendly
- * Outperforms industry standards
- * Hot plate Ignition
- * Best-in-class energy efficiency
- * Rust-proof exterior is long-lasting
- * 2" water connections

460792N	01M16520	175,000 BTU, DSI Electronic Ignition	\$2,203.00
460793P		* Fan assisted venting system	
460732N	02M18146	250,000 BTU, DSI Electronic Ignition	\$2,419.00
460733P		* Fan assisted venting system	
460736N	03M22784	400,000 BTU, DSI Electronic Ignition	\$3,037.00
460737P		* Fan assisted venting system	
		For ASME Rating, ADD	\$740.00



** NOTE: LPG units with *Electronic Ignition* **cannot** be installed indoors **without** fan assisted venting.

MINIMAX[®] Electronic Pilot Ignition...Nat or LP

- * Bronze Headers
- * Quick Flange allow 1-1/2" FIP connection
- * DSI-Direct Spark Ignition
- * 82% Thermal Efficiency

460347N / 48P	56M08768	MMX100, 100,000 BTU, DSI, Nat or LPG	\$1,168.00
---------------	----------	--------------------------------------	------------

Vent Kits for MiniMax 100

471357	77M1451	Outdoor Vent for 75/100 MiniMax	\$193.00
471187	79M1452	Indoor Vent for 75/100 MiniMax	\$193.00



VENT ADAPTERS and FLUE COLLARS

(For Master Temp pool heaters)

Vertical venting-Negative pressure

77707-0076	11M077895	4" x 6" Metal flue collar (vertical venting)	\$103.85
77707-0077	19M077898	4" x 8" Metal flue collar (vertical venting)	\$103.85

Horizontal or vertical venting---Positive pressure

77707-0086	22M083461	Appliance adapter, stainless steel	\$111.28
------------	-----------	------------------------------------	----------

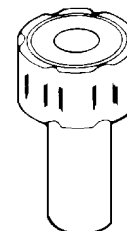

NOTES:

SECTION 18

POOL & SPA HEATERS

ITEM NUMBER	CONTROL NUMBER	PRODUCT DESCRIPTION	PRICE
-------------	----------------	---------------------	-------

COATES ELECTRIC HEATERS

208 or 240 Volts, 1 phase (MUST SPECIFY VOLTAGE)

R1423-12	01E015758	Model 12412 CE/12 KW	\$2,099.00
R1423-15	02E015936	Model 12415 CE/15 KW	\$2,124.00
R1423-18	03E016143	Model 12418 CE/18 KW	\$2,152.00
R1423-24	04E019996	Model 12424 CPH/24 KW	\$2,665.00

R1423-30	05E020321	Model 12430 CPH/30 KW	\$2,709.00
R1423-36	06E026329	Model 12436 PHS/36 KW	\$3,509.00
R1423-45	07E026999	Model 12445 PHS/45 KW	\$3,599.00
R1423-54	08E029964	Model 12454 PHS/54 KW	\$3,995.00

208/230/480V, 3 phase (MUST SPECIFY VOLTAGE & PHASE)

R1424-12-3	09E014935	12 KW, 208/240/480, 3 phase	\$1,991.00
R1424-15-3	10E015187	15 KW, 208/240/480, 3 phase	\$2,024.00
R1424-18-3	11E016149	18 KW, 208/240/480, 3 phase	\$2,152.00
R1424-24-3	12E018992	24 KW, 208/240/480, 3 phase	\$2,532.00

R1424-30-3	13E019434	30 KW, 208/240/480, 3 phase	\$2,591.00
R1424-36-3	14E023896	36 KW, 208/240/480, 3 phase	\$3,185.00
R1424-45-3	15E024256	45 KW, 208/240/480, 3 phase	\$3,233.00
R1424-54-3	16E027793	54 KW, 208/240/480, 3 phase	\$3,705.00

- * Stainless steel tank
- * Indoor or outdoor
UL listed
- * Manual reset hi-limit
- * Status lights
- * Flow switch
- * ASME approved
- * Pressure relief valve
- * Indicator lights



LARGER ELECTRIC HEATERS AVAILABLE...CALL WITH YOUR SPECIFICATIONS

COATES COMPACT HEATER— Model #ST

- * Built-in Flow Switch
- * Manual reset hi-limit
- * Stainless Steel Tank
- * 1-1/2" inlet/outlet with unions
- * Indoor or Outdoor, UL Listed
- * 220 Volt

12406ST	18E04979	5.5 KW, 240 volt, 1 phase	\$663.00
12411ST	19E05264	11 KW, 240 volt, 1 phase	\$699.00



COATES "IN-LINE" ELECTRIC HEATER

- * Stainless Steel Vessel
- * 1 1/2" Inlet/Outlet
- * Indoor/Outdoor, UL listed
- * Pressure Switch

R-1.5ILS	20E02855	1.44 KW, 120 volt, #1.5ILS	\$380.00
R-6ILS	21E03462	5.75 KW, 240 volt, # 6ILS	\$461.00



SECTION 19

POOL & SPA CONTROLLERS

ITEM NUMBER	CONTROL NUMBER	PRODUCT DESCRIPTION	PRICE
-------------	----------------	---------------------	-------

PENTAIR IntelliTouch®

An IntelliTouch system needs to include:

- * Load Center
- ** Personality kit
- *** Interface kit.



* **LOAD CENTER**—Required for use with *IntelliTouch* system

520136	44C005181	Main Panel <i>Load Center</i> with circuit breaker sub-panel (breakers not included)	\$690.00
--------	-----------	--	----------

** **INTELLITOUCH "PERSONALITY KITS"** ---Choose one:

Single body of water...pool or spa

520508	50C15176	i9+3S Load Center Personality Kit: 2 temp sensors, 9 relays, 3 feature functions & personality panel	\$2,023.00
--------	----------	---	------------

Separate equipment systems for pool AND spa w/ one controller

520510	51C17319	i10+3D Load Center Personality kit: 10 Relays, 3 features, personality panel, 2 temp sensors	\$2,308.00
--------	----------	---	------------

*** **INTERFACE KITS**--pick 520138 and/or 520139

520138	61C05645	Indoor Control Panel--3.75" LCD screen Wired to load center or power center	\$752.00
520906	62C09629	MobileTouch--Wireless control panel with transceiver, 3.75" LCD	\$1,283.00

IntelliTouch
Control Panel Features:

- * Control up to 40 functions
- * Sharp resolution screen
- * Back lighted w/ auto shut-off
- * Views available on the panel:
 - water temperatures
 - heating status
 - air temperature
 - status of all equipment
 - time and date
- * Customize buttons for easy ID
- * Simple on-screen menus

IntelliTouch Accessories

520149	60C05066	iS10, 10 Function spa side remote: Controls 10 circuits & temperature	\$675.00
520092	61C01891	iS4, 4 Function spa side remote: Controls 4 circuits, LED indicator lamps	\$252.00
520198	63C00954	2-Speed relay	\$127.00



520092

SECTION 19

AIR SWITCHES & BLOWERS

ITEM NUMBER	CONTROL NUMBER	PRODUCT DESCRIPTION	PRICE
-------------	----------------	---------------------	-------

LEN GORDON AIR SWITCHES

ADD AIR BUTTON TO AIR SWITCH KIT, IF NECESSARY

ASM-C95 921305001	07G098937	AS-MULTI COMBO-95,120/240V, 20 amps 1 or 2 HP, on/off for single piece of equip., will control single or 2-speed pump	\$131.91
AS-5 922990001	14G356681	AS-5, 240V, 1 to 3 phase, 50 amp, 5-10 HP, on/off control	\$475.57
AS-TD 921805001	12G144326	AS-TD Combo 95, 120/240V, 20 amp on/off control, 10 minute time delay, 1 to 2 HP. Neutral wire required	\$192.43
AS-5TD 922992-001	13G388677	AS-5TD-10MM, 240V, 50 amp, 5 to 10 HP, 10 minute time delay	\$518.23
FF1094 910100-007	08G182272	120/240V, 20 amp, 1 to 2 HP, controls 2 pieces of equipment with one air button. Controls 1 or 2 speed pump	\$243.03
951001	09G016888	#10 White "PowerTouch" flat air button	\$22.51
950401	10G019009	# 4 White "Lite Touch" air button	\$25.33
990310	11GPC1004	Tubing coupler	\$1.33
991020	12GP005102	20' Roll air tube	\$6.80
991100	13GP012485	100' Roll air tube	\$16.64

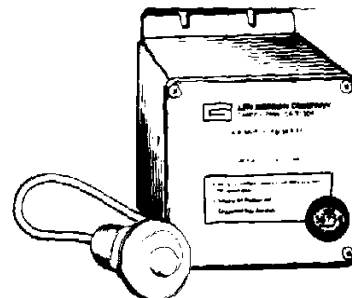

SPA BLOWERS

Residential Blowers---2" Bottom air outlet

1-460-01	01G01807	QT Blower, 1 HP, 110V	\$257.00
1-470-01	02G01949	QT Blower, 1½ HP, 110 V	\$277.00
1-480-01	03G02161	QT Blower, 2 HP, 110 V	\$309.00
Add 4% for 240 volt			

ROTRON

Commercial Blower---Belt Driven

R-505A7	05G17365	2 HP, 230/460V, 3 ph (DR505AS72M)	\$2,170.00
R-505AW	06G17814	2 HP, 115/230V, 1 ph (DR505AW58M)	\$2,226.00

POLARIS QT™

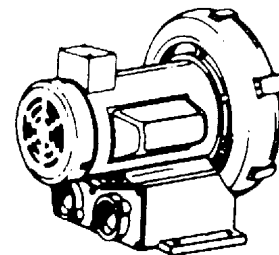
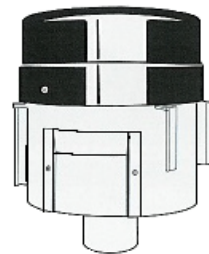

PROTECT YOUR FAMILY & INVESTMENT

- * Aesthetically pleasing
- * Custom fitted to your pool
- * Replaces conventional winter covers & water bags
- * Keeps your pool clean while protecting it from unwanted intruders and animals

NOW YOU SEE IT...
It's Summer...
It's inviting...
It's eye appealing...
IT'S BEAUTIFUL !!!

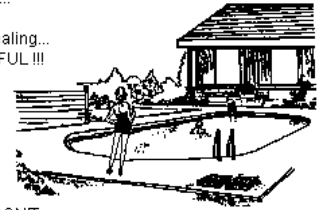

NOW YOU DON'T...
It's Winter...
It's "put to bed"
It's eye appealing...
IT'S BEAUTIFUL !!!

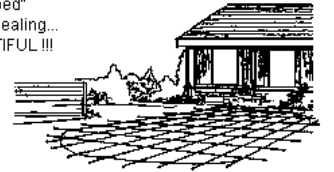

ITEM NUMBER	CONTROL NUMBER	PRODUCT DESCRIPTION	PRICE
-------------	----------------	---------------------	-------

SAFETY MESH COVERS -Rectangular **BIO-SHADE Material 5' X 5' Spacing**

Prices are for pools having up to **2' radius corners only** .
Any other corner requires a special quotation. Call for quote.

		COVER SIZE	//	POOL SIZE	
SC-1632	02SC08081	18 x 34	//	16 X 32	\$1,154.00
SC-1836	03SC09512	20 x 38	//	18 x 36	\$1,359.00
SC-2040	04SC10453	22 x 42	//	20 x 40	\$1,493.00
SC-2044	05SC11194	22 x 46	//	20 x 44	\$1,599.00
SC-2550	09SC15725	28 x 53	//	25 x 50	\$2,245.00
SC-3060	11SC21461	33 x 63	//	30 x 60	\$3,075.00
CUT OUT	07SC01194	Cut-outs...each			\$159.00
STEP	08SC01135	Step add-on...4' x 8' step			\$150.00

Custom and odd-shaped pools are our specialty. Call us for assistance and a price quote.

SAFETY " Solid " COVER Full Weight Rectangular **Heavy duty Material 12oz. Weight (Blue or Green)**

Prices are for pools having up to **2' radius corners only** .
Any other corner requires a special quotation. Call for quote.

		COVER SIZE	//	POOL SIZE	
SSC-1632	02SC010162	18 x 34	//	16 X 32	\$1,452.00
SSC-1836	03SC011837	20 x 38	//	18 x 36	\$1,690.00
SSC-2040	04SC013136	22 x 42	//	20 x 40	\$1,876.00
SSC-2044	05SC018081	22 x 46	//	20 x 44	\$2,583.00
SSC-2550	09SC025263	28 x 53	//	25 x 50	\$3,608.00
SSC-3060	11SC035392	33 x 63	//	30 x 60	\$5,055.00
CUT OUT	07SC001198	Cut-outs...each			\$159.00
STEP	08SC001485	Step add-on...4' x 8' step			\$197.00

PRICES FOR ALL SAFETY COVERS INCLUDE

- * Brass Concrete Anchors
- * Stainless Steel Hardware
- * Installation Tool

SECTION 21

WINTER COVERS

ITEM NUMBER	CONTROL NUMBER	PRODUCT DESCRIPTION	PRICE
-------------	----------------	---------------------	-------

IN-GROUND WINTER COVERS-- WATER TUBE TYPE

Water tubes not included in price

SUPREME GUARD W/ Binding--- 15 Year Limited, 2 Year Full Warranty

		COVER SIZE	//	POOL SIZE	
SL1729	10HP01063	17' x 29'	//	12' x 24'	\$163.00
SL1933	11HP01323	19' x 33'	//	14' x 28'	\$203.00
SL2137	01HP01619	21' x 37'	//	16' x 32'	\$248.00
SL2141	02HP01771	21' x 41'	//	16' x 36'	\$272.00
SL2341	03HP01935	23' x 41'	//	18' x 36'	\$297.00
SL2345	04HP02118	23' x 45'	//	18' x 40'	\$325.00
SL2545	05HP02316	25' x 45'	//	20' x 40'	\$355.00
SL2550	06HP02528	25' x 50'	//	20' x 45'	\$388.00
SL3050	07HP03084	30' x 50'	//	25' x 45'	\$474.00

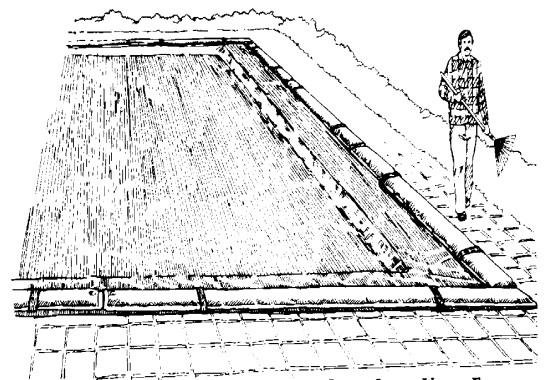
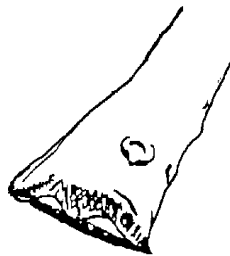

WATER TUBES

WT-8	02CA006829	8' Single Water Tube	\$10.49
WT-10	03CA008912	10' Single Water Tube	\$13.71
WT-8D	04CA007005	8' Double Water Tube	\$10.77
WT-10D	05CA009138	10' Double Water Tube	\$14.05

4x4 PILLOW	06C008132	4' x 4' Air Pillow	\$12.51
------------	-----------	--------------------	---------

ABOVE GROUND WINTER COVERS

SUPREME GUARD W/ Binding--- 15 Year Limited, 2 Year Full Warranty

		COVER SIZE	//	POOL SIZE	
SL-15	08HP0551	15' Round	//	12' Round	\$85.00
SL-18	09HP0754	18' Round	//	15' Round	\$115.00
SL-21	10HP0972	21' Round	//	18' Round	\$149.00
SL-24	11HP1243	24' Round	//	21' Round	\$191.00
SL-27	12HP1428	27' Round	//	24' Round	\$234.00
SL-31	13HP1995	31' Round	//	27/28' Round	\$306.00
SL-1833	14HP1449	18' x 33' Oval	//	15' x 30' Oval	\$222.00
SL-2136	15HP2104	21' x 36' Oval	//	18' x 33' Oval	\$323.00

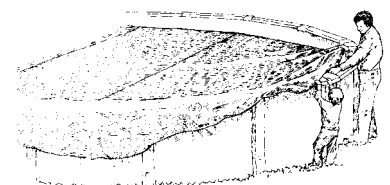

SECTION 21

WINTERIZING ACCESSORIES

ITEM NUMBER	CONTROL NUMBER	PRODUCT DESCRIPTION	PRICE
LITTLE GIANT Cover Pumps			
577301	01LG186231	Automatic Submersible pump, 1800 GPH, 1/3 HP, 25' PowerCord, garden hose connection... APCP1700 3-yr. Warranty	\$248.31



574027	02PF122762	Pool Cover Pump Kit, #PCPK , 325 GPH, 18' cord, 25' 1/2" tubing, hose adapter	\$163.68
--------	------------	---	----------



RUBBER WINTERIZING PLUGS

HWP-204	15PV01780	#4 Rubber Plug, (3/4" & 1" pipe)	\$2.54
HWP-206	16PV02004	#6 Rubber Plug, (1" pool fitting)	\$2.86
HWP-207	17PV02181	#7 Rubber Plug, (1 1/4" pipe)	\$3.11
HWP-208	18PV02489	#8 Rubber Plug, (1 1/4" pool fitting)	\$3.54
HWP-209	19PV02538	#9 Rubber Plug, (1 1/2" pipe)	\$3.61
HWP-210	20PV02654	#10 Rubber Plug, (1 1/2" pool fitting)	\$3.79
HWP-211	21PV03852	#11 Rubber Plug, (2" pipe)	\$5.50
HWP-212	22PV04238	#12 Rubber Plug, (2" pool fitting)	\$6.04
552622	23PV01579	Threaded plug w/ O-ring, 1 1/2"	\$2.24
195830	91V006625	Threaded plug w/ O-ring, 2"	\$9.46

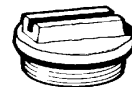

BRASS ANCHOR

C50-B	09CA004283	Brass Concrete Anchor	\$6.58
MH205	10CA301994	Brass Concrete Insert only	\$2.86



SKIMMER BLOWOUT EXTENSIONS

R1197	08SK010462	15" Skimmer Blowout Extension	\$13.95
SKG9	191K005506	9" Expansion Skimmer Insert	\$7.33

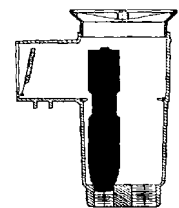

Anti-Freeze for pools & spas

R10306-1	01AF07174	Gallon jug	\$9.56
R10306-2	02AF40317	Case 6 x 1 gallon	\$53.75



SECTION 21

SPA COVERS

ITEM NUMBER	CONTROL NUMBER	PRODUCT DESCRIPTION	PRICE
-------------	----------------	---------------------	-------

DELUXE MODEL

by
MERLIN

- * 2# Density Polystyrene Foam Inserts
- * Inserts Heat Sealed inside 6-mil Vapor Wrap
- * Aluminum "C" Channel Foam Reinforcements
- * Standard Skirt Size---3"...up to 6" No Extra Charge
- * Colors: Teak, Light Gray, Dark Gray, Blue, Tan, Forest Green
- * Bi-fold, 4" x 2" Tapered Foam Top
- * Tri-fold & Quad Fold Available
- * Three (3) Year Limited Warranty
- * 4 Security Straps with Locking Buckles

DM86	22SC05208	Up to 86"	\$693.00
DM96	23SC05487	86.5" to 96"	\$731.00
DM120		96.5" to 120"	Quote on request
DM144		120.5" to 144"	Quote on request

PORTABLE SPAS WITH SPECIAL CUT-OUTS SUCH AS BAJA, ADD			
CO-AO	56SC00582		\$77.00

For any tri-fold or quad-fold, submit drawing for quote.

ULTRA MODEL

ULTRA MODEL---5 year limited warranty

- Supports heavy snow loads, small children, dogs, etc.
- Tough fiberglass reinforced plastic cover
- 4" x 3" Taper
- Deluxe moisture barrier---HD 6-mil co-extruded, triple layer wrap
- Aluminum "C" channel reinforcements

All spa covers must have a drawing submitted in detail before cover can be ordered.

All spa covers are special order and are to be paid in full with order.

UM86	32SC08236	Up to 86"	\$1,097.00
UM96	33SC08231	86.5" to 96"	\$1,097.00
UM120		96.5" to 120"	Quote on request
UM144		120.5" to 144"	Quote on request

THERMO-LIGHT----- Floating Spa Cover

For larger and free-form spa covers that can be too heavy or too big with the standard construction method. Using the finest marine grade vinyl and a special foam core, the Thermo-Light is made to last and not absorb water.

Dimensions are to be the water's edge...it floats inside the pool/spa on the water.

TL86	81SC06990	Up to 86"	\$932.00
TL96	82SC06993	86.5" to 96"	\$932.00
TL965		96.5" and bigger	Quote on request

SECTION 22

LINER ACCESSORIES

ITEM NUMBER	CONTROL NUMBER	PRODUCT DESCRIPTION	PRICE
-------------	----------------	---------------------	-------

LINER BEAD RETAINER

RLOCK	01LA028574	LOK-N-ROLL , 2/100' coils	\$40.81
QP1562	02LA024238	Ribbed bead lock, 120' (QP1562)	\$34.61

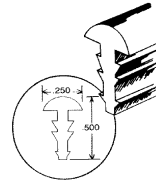

LINER BEAD RECEIVER

QP-531	03LA005326	Top Mount, 8' pc	\$7.60
QP-531C	04LA313992	Top Mount, 512' case, 64/8' pieces	\$448.56
QP-532	05LA021249	Top Mount, 6" corner kit	\$30.34
VM-1	06LA157518	Aluminum Side Mount Case 15/8' pc (120')	\$210.01

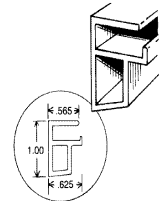
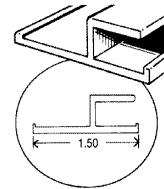

VINYL COPING CAP & CORNERS

242316	02V007600	White Vinyl Coping Cap, 8" x 124'	\$1,086.00
42321	03V140009	8" Corner Bracket, set of 4	\$199.00

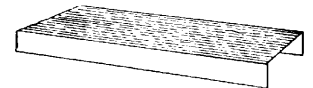

WALL/FLOOR FOAM & ADHESIVE

WF125	71PF99990	2 lb. X 1/8" x 125' Roll foam	\$133.32
AF100	82PF13486	MagicBond, 15 oz. Spray Adhesive	\$19.26



VINYL PATCH KITS

759	01VR002983	Vinyl Repair Kit, 1 oz	\$3.97
859	03VR005432	Vinyl Repair Kit, 2 oz	\$7.24
110	05VR011083	Vinyl Repair Kit, 4 oz	\$14.77
104	07VR008407	Vinyl Cement only, 4 oz	\$11.20

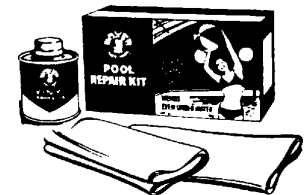

6 62	08VR164005	5-Gal. Stain Barrier (Prevents stains from underneath vinyl liners due to microorganisms in soil).	\$234.00
------	------------	--	----------



ITEM NUMBER	CONTROL NUMBER	PRODUCT DESCRIPTION	PRICE
-------------	----------------	---------------------	-------

INGROUND LINERS

- The selection of liner patterns and designs is vast; no more "standard liners"
- Vinyl liners are now "Price on Request"
- Please call us with your pool make, all dimensions (see drawings), and pattern desired
- Customer is ultimately responsible for all final liner dimensions
- Call for literature, patterns and/or pricing

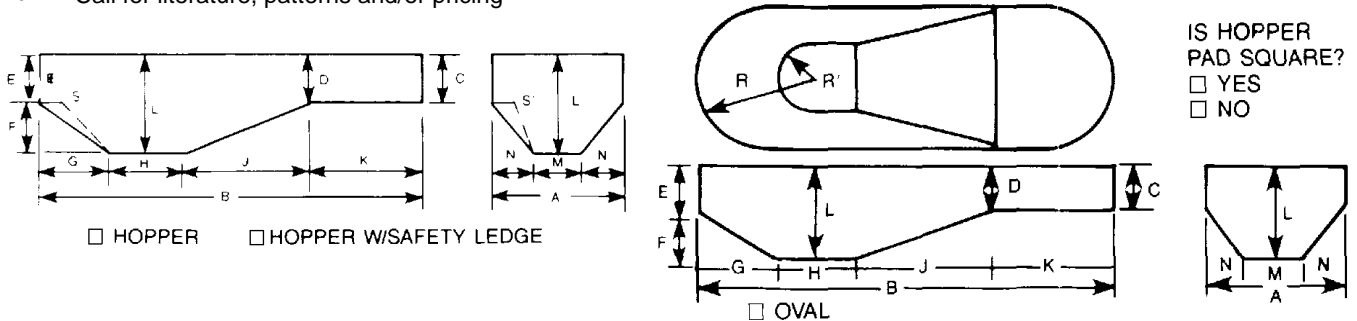

Below is a *small sampling* of vinyl liners available. There are many liner manufacturers to choose from. Patterns and prices are different between the manufacturers, therefore, final pricing may vary. Call us for more information.

1530OBL	04C00001	15' x 30' Oblong	CALL
1735OBL	05C00018	17' x 35' Oblong	CALL
1937OBL	06C00056	19' x 37' Oblong	CALL
1943OBL	07C0R006	19' x 43' Oblong	CALL
1632RT	09C00T03	16' x 32' Rectangle	CALL
1836RT	11C00A08	18' x 36' Rectangle	CALL
2038RT	10C0G0B7	20' x 38' Rectangle	CALL
2040RT	12C00026	20' x 40' Rectangle	CALL

ANY Shape Liner Available

Kidney ?
 True L ?
 Lazy L ?
 Grecian ?
 Roman ?
 Free Form ?

We are the Liner Experts !
Call ROGERS !

ALUMINUM COPING

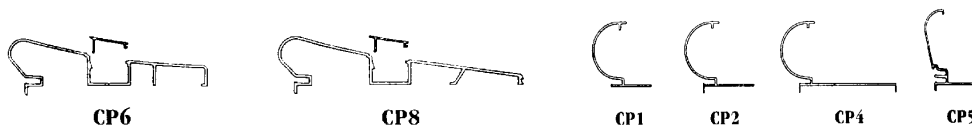

SECTION 23

POOL PAINT

ITEM NUMBER	CONTROL NUMBER	PRODUCT DESCRIPTION	PRICE
-------------	----------------	---------------------	-------

KELLEY EPOXY PRIMER

PRIMERS

PP-214G	43KP055204	Poxoprime II, gallon	\$78.85
PP-214QT	44KP018414	Poxoprime II, quart	\$26.30
GUN-216G	45KP056276	Gunzite Primer, gallon	\$80.39
GUN-216QT	46KP018916	Gunzite Primer, quart	\$27.02
MP-219G	47KP061679	Steel Primer, gallon	\$88.10
MP-219QT	48KP020799	Steel Primer, quart	\$29.70

KELLEY EPOXY POOL PAINT

POXOLON 2

#2228 Bikini Blue #2225 Blue Ice #2226 Black
#2231 Blue Mist #2222 White

Batch Code	22KP086398	Poxolon Gallon with Catalyst	\$123.42
Batch Code	23KP028747	Poxolon Quart with Catalyst	\$41.05
* Special colors available. Set-up charges apply			\$50.00
ES-1109QT	24KP008044	Epoxy Solvent #1109, quart	\$11.49
ES-1109G	25KP024659	Epoxy Solvent #1109, gallon	\$35.21

ZERON

#392 Bikini Blue #390 White #399 Black
#395 Blue Mist #391 Blue Ice

Batch Code	26KP088495	Zeron Gallon with Catalyst	\$126.41
Batch Code	27KP029062	Zeron Quart with Catalyst	\$41.51
* Special colors available. Set-up charges apply			\$50.00
ES-1109QT	28KP008044	Epoxy Solvent #1109, quart	\$11.49
ES-1109G	29KP024659	Epoxy Solvent #1109, gallon	\$35.21

ACCENT & DESIGN EPOXY

POXOLON BRIGHT COLORS---Catalyst included in price

BCP-2201G	49KP096561	#1 Red Pepper, gallon	\$137.94
BCP-2201Q	53KP031651	#1 Red Pepper, quart	\$45.22
BCP-2203G	50KP096563	#3 Sunshine Yellow, gallon	\$137.94
BCP-2203Q	54KP031653	#3 Sunshine Yellow, quart	\$45.22
BCP-2212G	51KP096569	#12 Viking Blue, gallon	\$137.94
BCP-2212Q	55KP031659	#12 Viking Blue, quart	\$45.22
BCP-2211G	52KP096568	#11 Spanish Blue, gallon	\$137.94
BCP-2211Q	56KP031658	#11 Spanish Blue, quart	\$45.22

- POXOPRIME II**
- * Seals surface
 - * Reduces downtime
 - * Cleans up with water

- GUNZITE**
- * Filler & primer
 - * Apply over gunite
 - * Smooth finish

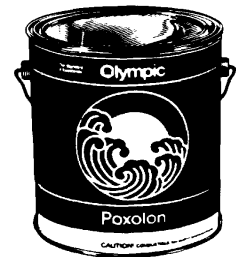

- POXOLON 2**
- * 2 coat epoxy
 - * Tile-like finish
 - * Resists staining
 - * Easy to clean surface

- ZERON**
- * One coat epoxy
 - * 2 times thicker than Poxolon
 - * Lasts up to 8 years

- BRIGHT COLORS**
- * Artistic decorative colors
 - * Accent & detail images
 - * Highlight for safety purposes

SECTION 23

POOL PAINT

ITEM NUMBER	CONTROL NUMBER	PRODUCT DESCRIPTION	PRICE
-------------	----------------	---------------------	-------

CHLORINATED RUBBER BASE

PARALON

	#292 Bikini Blue	#291 Blue Ice	#290 White
	#295 Blue Mist	#297 Black	
Batch Code	KP060349	Gallon	\$86.20
Batch Code	KP020173	Quart	\$28.82
* Special colors available. Set-up charges apply			\$50.00
RBS-1108G	11KP027428	Solvent #1108, gallon	\$39.16
RBS-1108QT	12KP008958	Solvent #1108, quart	\$12.78



PARALON 2

- * Soft Pastel Finish
- * Easy to apply
- * Long Lasting

PATIO TONES

	Desert Sun, #W-463	Warm Biscuit, #W-478	
	Sand Valley, #W-465	Creekstone, #W-466	Ivory, #W-475
	Champagne, #W-469	Silk Straw, #W-467	Mystic Gray, #W-472
Batch Code	KP045189	Gallon	\$64.54
Batch Code	KP014931	Quart	\$21.33
* Special colors available. Set-up charges apply			\$50.00

PATIO TONES

- * Makes It New Again
- * Covers ugly repairs
- * Non-slip Finish

REPAIR PRODUCTS

CONCRETE REPAIR PRODUCTS

POF-962G	57KP064552	Pox-O-Fill #962, gallon w/ catalyst	\$92.21
POF-962QT	58KP021433	Pox-O-Fill #962, quart w/ catalyst	\$30.61
CP960G	59KP035925	Concrete Patch #960, gallon, w/ catalyst	\$51.32
CP960QT	60KP012008	Concrete Patch #960, quart, w/catalyst	\$17.14
TL-935V	60KP089404	Thermolastic #935, gal, vertical, w/cat	\$127.71
TL-935H	61KP089407	Thermolastic #935, gal, horizontal, w/cat	\$127.71

POX-O-FILL

- * Hi-strength epoxy
- * Fills large cracks
- * No "cold joint"
- * Anchor compound

CONCRETE PATCH

- * Economical
- * Easy application
- * "Holds" underwater

THERMOLASTIC

- * Expansion joints
- * Stays flexible
- * Can be painted

A paint job is only as good as the surface preparation. You want it so clean you could "eat off of it".

Step #1---Clean the pool surface with #910 *Pool Wash* to break down oils and dirt left on the surface...
rinse...pump out the rinse water.

Step #2---Acid wash surface with a 2:1, water to muriatic acid...rinse...pump out acid solution carefully.

Step #3---Repeat Step #1...allow surface to dry and reach proper temperature before applying paint.

OR DO IT THE EASY WAY!

Step #1---Mix PREP A according to directions (PREP A + water + acid)...apply to surface...rinse...pump out.

Step #2---Allow surface to dry and reach proper temperature before applying paint.

See page 59 for "PREP A"

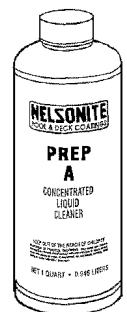

SECTION 23

PAINT ACCESSORIES

ITEM NUMBER	CONTROL NUMBER	PRODUCT DESCRIPTION	PRICE
-------------	----------------	---------------------	-------

PREP A---Concentrated Liquid Concrete Cleaner & Prep

59190	78N0020324	Prep A, 32 oz bottle	\$27.09
59191	79N0233882	Prep A, Case of 12/32 oz bottles	\$311.84

POOL WASHING COMPOUND

TSP-910G	64KP021299	Pool Wash #910 (TSP), gallon (4000 sf)	\$30.42
TSP-910QT	65KP006958	Pool Wash #910 (TSP), quart (1000 sf)	\$9.93

SKID MIX---Non-skid Paint Additive

SM-905G	62KP017045	Skid Mix #905, gallon	\$24.34
SM-905QT	63KP005724	Skid Mix #905, quart	\$8.17

PAINT TOOLS

X93119	66KP012013	Roller Frame, 9" Deluxe	\$17.15
X83529	67KP008945	Roller Cover, 9", 3/4" nap Synthetic Fiber	\$12.77
9600/9004H	68AB016846	Acid/Tile Brush w/60" Thrd. Handle	\$25.91
9600	69AB011927	Dual-Sided Acid Brush Only	\$18.34
9004H	70AB004928	60" Thrd. Wooded Handle	\$7.57



PREP A--One Step Surface Preparation

- * Use w/ acid for prep
- * Reduces acid fumes
- * Thickens solution for better cleaning
- * One quart / 500 S.F.
- * Biodegradable

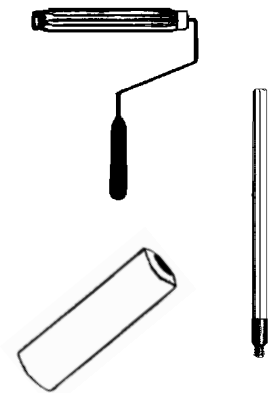

SECTION 24

EPOXY PRODUCTS

ITEM NUMBER	CONTROL NUMBER	PRODUCT DESCRIPTION	PRICE
-------------	----------------	---------------------	-------

EPOXY BOND POOL PUTTY: 2-part epoxy sticks
Available in "White" or "Black" color

530318-1	17PP010295	Pool Putty, 1# 2-part kit (White)	\$13.72
530318-5	18PP049054	Pool Putty, case 5 x 1# 2- part kit	\$65.40
530317-1	19PP016506	Pool Putty, 1# 2-part kit (Black)	\$21.99



Notes:

AQUAFIX Epoxy Repair & Maintenance Products

RIGIDFIX---Apply on dry surfaces or underwater

- * Stops leaks caused by water pressure
- * Mends PVC, skimmers, dams

AF332	04PP113912	RigidFix Crack Repair, 64 oz	\$162.73
AF333	05PP196839	RigidFix Crack Repair, 132 oz	\$281.19

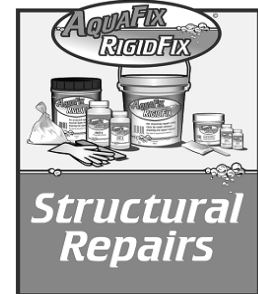

Save Time! Save a Mess! Gun It On!!

FLEXFIX Rapid Set -Flexible Epoxy Patch: Single & dual barrel systems

- * Repair cracks, even underwater
- * Non-shrinking
- * Flexible to withstand pool movement

AF349	37PP100920	Dual 20 oz cartridge	\$144.17
-------	------------	-----------------------------	----------

** Gun is a dual barrel caulking gun. This flexible epoxy product is pumped through and mixed in the special mixing tip. Mixing time is SAVED and NO MESS to clean up.*



AF351	38PP0051291	Single 8.5 oz. cartridge	\$73.27
-------	-------------	---------------------------------	---------

Designed for use in a standard single barrel dispenser gun. Unique cartridge design contains both epoxy components.

AF350	78PP003863	Mixing tip for <i>RapidFix</i> cartridges	\$5.51
-------	------------	---	--------



FLEXFIX---Flexible Epoxy...Apply on dry surfaces or underwater

AF341	03PP113913	FlexFix Anti-Sag, 64 oz	\$162.73
AF342	04PP170982	FlexFix Anti-Sag, 132 oz	\$244.26

HYDROSEAL---Seals Weepers in Concrete

- * Bonds to concrete
- * Fills voids behind pool walls
- * Remains flexible
- * Foam expands on contact w/water

AF550	01PP065484	10.5 oz Single caulk tube	\$93.54
-------	------------	---------------------------	---------

** Remains flexible * Foam expands on contact w/water*



SECTION 24

CAULK & SEALANTS

ITEM NUMBER	CONTROL NUMBER	PRODUCT DESCRIPTION	PRICE
-------------	----------------	---------------------	-------

POLYURETHANE JOINT SEALANTS

VUL45SSL	16PP024998	Vulkem 45 SSL, 30 oz. tube, limestone Other colors: white, black, gray & buff	\$35.70
VUL116	25PP008997	Vulkem #116, 10 oz., white or alum Other colors: gray, black & buff	\$12.84

PERMANENT SEALER

PS-10W	19PP005827	White, 10.6 oz. caulk tube	\$7.76
PS-10W24	20PP127993	White, case 24 x 10.6 oz. tubes	\$170.65
PSW-10HV	24PP005824	White, <i>HI-Viscosity</i> 10.6 oz. tube	\$7.76
PSW-10HV-24	25PP127995	White, case 24 x 10.6 <i>H-V</i> tubes	\$170.65
PSCG-10HV	26PP005826	Aluminum, 10.6 oz caulk tube	\$7.76
PS-10CL	29PP008361	Clear, 10.6 oz. caulk tube	\$11.14
PS-4W	21PP004132	White Squeeze Tube, 4 oz	\$5.50
PS-4WC	22PP004133	Clear Squeeze Tube, 4 oz	\$5.50

PVC GLUE..THREAD SEALANTS..LUBRICANTS

PVC PRIMER & CEMENT

795PT	01PA012026	Clear cement, #795, pint	\$18.49
P68PT	02PA008899	Primer, pint #P68	\$13.68
747QT	03PA012184	Blue cement, fast setting quart #747	\$18.74
747½PT	04PA005442	Blue cement, fast setting ½ pint #747	\$8.37

PIPE THREAD SEALANTS AND SILICONE LUBE

TEF260	05PA001369	Teflon Tape, 260" roll	\$2.47
TEF2606	06PA015116	Teflon Tape, case of 12 x 260"	\$27.47
PJS1	07PA003699	Plasto-Joint Stick	\$5.27
PJS12	08PA020304	Plasto-Joint Stick, case of 6	\$28.99
R650	09PA005143	Magic Lube, 1 oz. silicone lube	\$6.85
R651	21PA018548	Magic Lube, 5 oz. silicone lube	\$24.72
R640	28PA007704	Magic Lube <i>Green</i> , 3 oz. w/ Kevlar	\$10.26

STAINLESS STEEL CLAMPS

R15513	24PF01741	Clamp, 1½" / 2"	\$2.32
--------	-----------	-----------------	--------

VULKEM 116:

* One-part polyurethane, non-sagging flex system
USE: Horizontal & vertical joint sealer

VULKEM 45 SSL:

* One-part polyurethane, *semi-self leveling* system
USE: Horizontal joints up to 6% slope.

PERMANENT SEALER:

* *Nitrile rubber* sealant for cracks & holes in concrete, wood, glass, & aluminum
* Flexible, fast-curing, self-leveling. Can apply underwater
USE: Horizontal seams

PERMANENT SEALER HV:

Same as above except:
* Non-sagging
USE: Horizontal & vertical seams

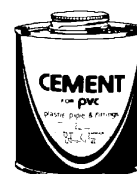

SECTION 26

PLUMBING SUPPLIES

ITEM NUMBER	CONTROL NUMBER	PRODUCT DESCRIPTION	PRICE
FLEXIBLE PVC			
FPVC-3/4	06PB71630	3/4" x 100' Coil	\$95.51
PVC-3/4	07PB00836	3/4" per foot	\$1.11
FPVC1	08PB73248	1" x 50' Coil	\$97.65
PVC-1	09PB01686	1" per foot	\$2.24
FPVC-1 1/4	10PF103884	1 1/4" x 50' Coil	\$138.51
PVC-1 1/4	11PB002395	1 1/4" per foot	\$3.19
FPVC-1 1/2	12PB103823	1 1/2" x 50' Coil	\$138.51
PVC -1 1/2	13PB002391	1 1/2" per foot	\$3.19
FPVC -2	15P157474	2" x 50' Coil	\$209.96
PVC-2	16PB03629	2" per foot	\$4.83
R139PT	17PT05910	PVC Hand Wire Saw Cable	\$8.44

PVC PIPE FITTINGS- SCH 40

ELBOWS 1-1/2"

406-015	41PF01751	90° Elbow, 1 1/2" slip x slip	\$2.33
409-015	38PF03622	90° Street, 1 1/2" slip x slip	\$4.83
412-015	39PF03805	90° Street, 1 1/2" MPT x FPT	\$5.06
417-015	40PF02477	45° 1 1/2" slip x slip	\$3.29

ELBOWS 2"

406-020	42PF02756	90° Elbow, 2" slip x slip	\$3.66
409-020	84PF06996	90° Street Elbow, 2" slip x slip	\$9.32
417-020	85PF03218	45° Street, 2" slip x slip	\$4.28
21005	86PF04177	Sweep elbow- 2" x 2" slip x slip	\$5.56

SLIP ADAPTERS

436-015	28PF01359	Male Adapter, 1 1/2" slip x MPT	\$1.80
436-020	29PF01765	Male Adapter, 2" slip x MPT	\$2.35
435-015	30PF01356	Female Adapter, 1 1/2" slip x FPT	\$1.80
435-020	27PF01802	Female Adapter, 2" slip x FPT	\$2.40

COUPLINGS

429-015	53PF01071	1 1/2" slip x slip	\$1.43
429-020	48PF01649	2" slip x slip	\$2.19

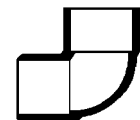
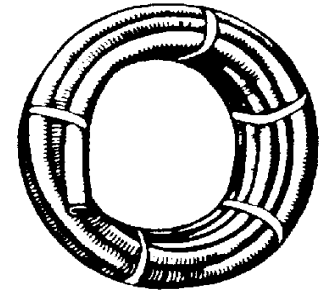

90 ELBOW
(slip x slip)

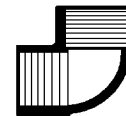

90 ELBOW
(FPT x FPT)

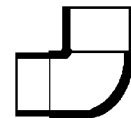

90 STREET ELL
(SP x slip)

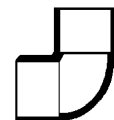

90 ELBOW
(slip x slip)



45 ELL
(slip x slip)

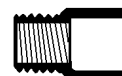

MALE ADAPTER
(MPT x slip)



FEMALE ADAPTER
(FPT x slip)



COUPLING
(slip)

SECTION 26

PLUMBING SUPPLIES

ITEM NUMBER	CONTROL NUMBER	PRODUCT DESCRIPTION	PRICE
-------------	----------------	---------------------	-------

PVC PIPE FITTINGS- SCH 40

TEES

401-015	44PF02333	Tee, 1½" slip x slip x slip	\$3.10
405-015	45PF06497	Tee, 1½" FPT x FPT x FPT	\$8.65
401-020	46PF03382	Tee, 2" slip x slip x slip	\$4.51

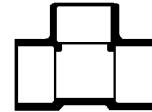

TEE
Slip x Slip x Slip

NIPPLES

1½CN	49PF01252	Close Nipple, 1½" MPT x MPT	\$1.66
1½ 5	51PF02098	Nipple 1½" x 5" MPT x MPT	\$2.77
1½ 6	52PF02391	Nipple 1½" x 6" MPT x MPT	\$3.18



PIPE EXTENDERS-*Mend & Extend PVC Pipe*

21181-15	74PE03415	Extender for 1½" PVC pipe	\$4.55
21181-20	78PE03417	Extender for 2" PVC pipe	\$4.55

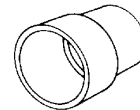

REDUCING BUSHINGS

437-251	49PF02059	Slip 2" x 1½" slip	\$2.73
436-251	51PF04263	Comb 2" x 1½" MPT x slip	\$5.68
439-251	35PF03268	2" x 1½" MPT x FPT	\$4.83
439-131	31PF01887	1" x ¾" MPT x FPT	\$2.51
439-211	32PF03382	1¼" x 1" MPT x FPT	\$4.51
439-210	33PF03389	1½" x ¾" MPT x FPT	\$4.51
439-211	34PF03385	1½" x 1" MPT x FPT	\$4.51
437-211	37PF001244	Slip 1½" x 1" slip	\$1.65
437-210	37PF001242	Slip 1½" x ¾" slip	\$1.65
438-210	36PF02176	Comb 1½" x ¾" slip x FPT	\$2.89
474-015	39PF03297	1½" Combo-poly insert x slip	\$4.38

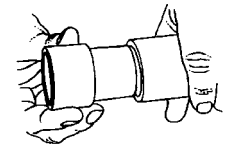

REDUCER BUSHING
(SP x Slip)

PVC UNIONS

PUMP TYPE HIGH TEMPERATURE UNION--MPT x slip

21063-150	01PV10431	1½" MPT w/ o-ring x 1½" slip	\$14.90
21063-200	02PV13882	2" MPT w/ o-ring x 2" slip	\$19.83

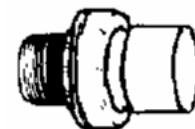

STANDARD UNION

21049-150	12AF07330	CMP union 1½" slip x slip	\$10.47
21049-200	13AF08671	CMP union 2" slip x slip	\$12.39

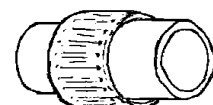

SECTION 26

PLUMBING SUPPLIES

ITEM NUMBER	CONTROL NUMBER	PRODUCT DESCRIPTION	PRICE
-------------	----------------	---------------------	-------

TRUE UNION BALL VALVES

Sch 80, EDPM seals

TRUE SINGLE UNION---Pinned for Easy Seat Removal for Servicing

*** A handle that turns...**even with union nut over-tightened!**

Our best seller...our best value !

150-010	69BV018405	1½" True Single Union, s x s	\$24.53
200-010	70BV025566	2" True Single Union, s x s	\$34.08

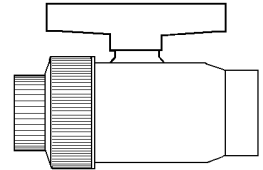

BALL VALVES ---Single Union

PV1450 -1½	04PV010814	1½" PVC Ball Valve, (S x S)	\$14.41
PT-015	51PV018846	1½" PVC Ball Valve, (FPT x FPT)	\$25.12
PV1450-2	05PV014312	2" PVC Ball Valve, (S x S)	\$19.08
HMIP300SE	47PV045128	3" PVC Ball Valve, s x s (non-union)	\$60.16

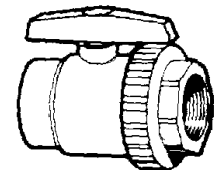

Motorized or Manual Diverter Valves

263028	50PV036869	2" PVC Diverter Valve, 3-way , s x s x s Use manually or with an actuator for a motorized valve.**	\$49.14
263029	95PV031305	2" PVC Diverter Valve, 2-way , s x s Use manually or with an actuator for a motorized valve.**	\$41.73
263045	18G001417	**24 volt valve actuator for above valves	\$188.00

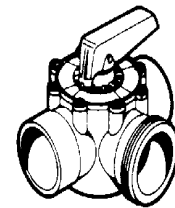

GATE & CHECK VALVES

R1558-15	09PV023767	Bronze Gate Valve, 1½" MPT	\$31.68
R1558-2	08PV034519	Bronze Gate Valve, 2" MPT	\$46.01
25830-150	09PV039092	Spring-load swing check valve, 1½"	\$52.12
25830-200	10PV039935	Spring-load swing check valve, 2"	\$53.24
R1520-15	09PV013842	PVC Swing Check Valve, 1½"	\$18.45
R1520-20	10PV021155	PVC Swing Check Valve, 2"	\$28.20

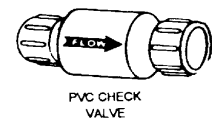

PVC CHECK VALVE

SECTION 26

PLUMBING SUPPLIES

ITEM NUMBER	CONTROL NUMBER	PRODUCT DESCRIPTION	PRICE
-------------	----------------	---------------------	-------

BUTTERFLY VALVES

PVC Body, Flanged, EDPM Seals

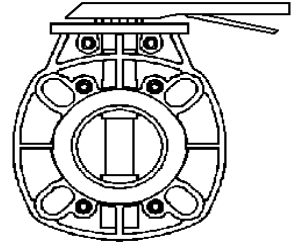

BPFV3	25BF099059	3" Butterfly Valve	\$165.08
BPFV4	26BF112863	4" Butterfly Valve	\$188.10
BPFV6	27BF185207	6" Butterfly Valve	\$308.67
BPFV8	28BF272779	8" Butterfly Valve	\$454.62

GEAR OPERATED BUTTERFLY VALVES AVAILABLE. CALL FOR PRICE.

FLANGES

Sch 80 Two-piece Van Stone Style

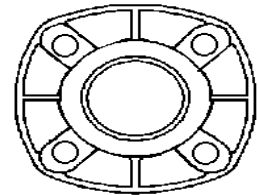

PF3	40BF011134	3" Flange	\$19.87
PF4	41BF014892	4" Flange	\$26.59
PF6	42BF024011	6" Flange	\$42.87
PF8	43BF038834	8" Flange	\$69.34

BUTTERFLY FLANGE BOLTS

BBK3	50BK09896	5/8" x 5 1/2", 4 per kit	\$16.48
BBK4	51BK18182	5/8" x 6", 4 per kit	\$30.30
BBK6	52BK23963	5/8" x 6 1/2", 8 per kit	\$39.93
BBK8	53BK26725	5/8" x 7", 8 per kit	\$44.53

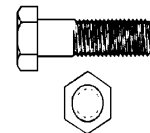

SECTION 27

DECK FORMS & DRAINS

ITEM NUMBER	CONTROL NUMBER	PRODUCT DESCRIPTION	PRICE
-------------	----------------	---------------------	-------

STEGMEIER CONCRETE COPING FORMS

CANTILEVER "REGULAR"---Case includes: 112' form, 112' tile strip, tie wire kit

1CF112	01CF3674	Case 14/8', single case	\$489.00
1CF1122	02CF3405	Case 14/8', 2 or more cases, each	\$453.00

CANTILEVER "CAPSTONE"---Case includes 112' form, 112' tile strip, tie wire kit

9CF112	03CF3672	Case 14/8', single case	\$489.00
9CF1122	04CF3409	Case 14/8', 2 or more cases, each	\$453.00

CANTILEVER "SANDSTONE"---Case includes: 80' form, 80' tile strip, tie wire kit

17CF112	05CF3677	Case 10/8', single case	\$489.00
17CF1122	06CF3409	Case 10/8', 2 or more cases, each	\$453.00

STEGMEIER SUPER DECK DRAIN

SUPER DRAIN uses 1-1/2" sch. 40 PVC as adapters & couplings.

SRW (white)	01DW04103	Case 8 / 10' sections, includes: 8 couplers & 4 end adapters	\$586.00
SRG (grey)			
SRW-1 (W / G)	02DW53344	Super Drain, Single 10' section	\$76.20
SR9 (W / G)	07DW10048	Single 90° Angle (10 per carton)	\$13.39
SR4 (W / G)	08DW10041	Single 45° Angle (10 per carton)	\$13.39
SRT (W / G)	09DW16679	Single Tee (4 per carton)	\$22.23
SRX	10DW22628	Single Cross (2 per carton)	\$30.16
SRSA	11DW13695	Single Side Adapter (4 per carton)	\$18.25
SRDA	12DW13693	Single Down Adapter (4 per carton)	\$18.25

ROGERS stocks (W) white and (G) gray. (T)Tan & (B) black available by special order.

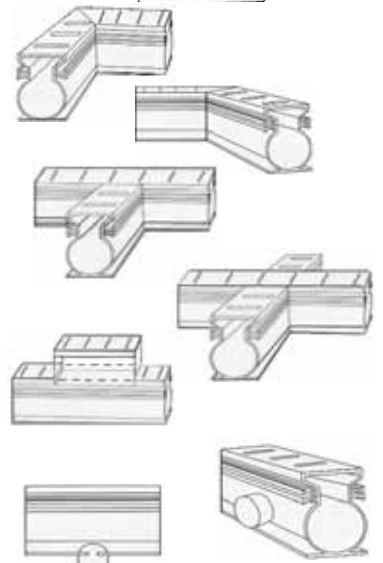
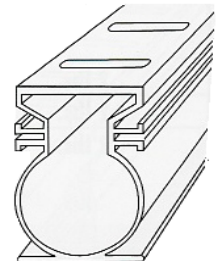
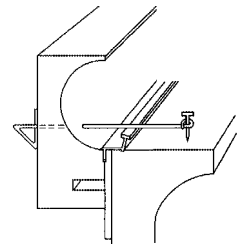
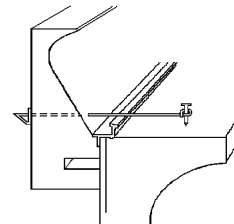
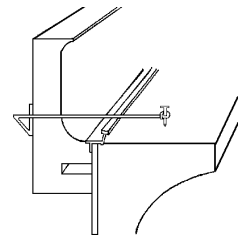

SECTION 28

DECK FOUNTAIN JETS

ITEM NUMBER	CONTROL NUMBER	PRODUCT DESCRIPTION	PRICE
-------------	----------------	---------------------	-------

JANDY® DECK JETS™

The Jandy deck jets shoot shimmering arcs of water from the deck into the pool. Polished bronze coverplates provide a rich finish to the installed jets. Being fully adjustable up to 360°, many combinations of installation are available and can still be changed any time.

JDJ2004	15DJ336226	Jandy Deck Jet, set of four (4), includes: pressure testing plug and coverplates	\$448.29
R0561200	25DJ040021	Replacement coverplate, set of four	\$53.36
R0560400	35DJ077332	Nozzle replacements, set of four	\$103.11

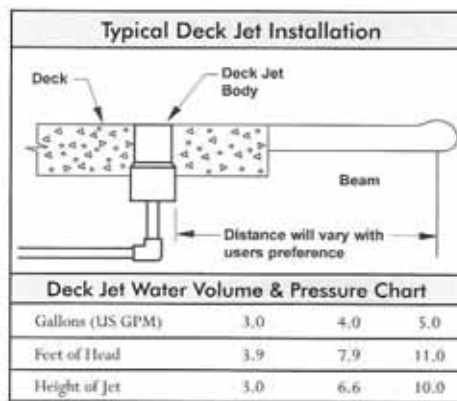

PENTAIR DECK JET

- * Includes five (5) interchangeable water effect eyeballs
- * Streams reach to 8 feet and direction can be easily adjusted
- * Jets install flush to surfaces
- * Easy to change water eyeballs
- * Low water pressure and flow required



580000	45DJ097307	Pentair Deck Jet, each kit	\$129.73
--------	------------	----------------------------	----------

		THROW DISTANCE IN FEET						
		2	3	4	5	6	7	
Fan	gpm	-	1	1.2	1.3	1.5	1.9	
	psi	-	1.8	2.2	2.6	3.6	4.8	
	spread	-	12 in.	24 in.	36 in.	60 in.	96 in.	
	height	-	12 in.	18 in.	24 in.	36 in.	48 in.	
3 Stream	gpm	1.3	1.6	1.9	2.2	2.5	2.8	
	psi	2	2.5	3.5	4.2	5	6	
	spread	8 in.	12 in.	18 in.	20 in.	24 in.	30 in.	
3/16 in. Single Stream	gpm	0.4	0.5	0.7	0.7	0.8	0.9	
	psi	1.5	2	2.4	2.8	3.2	3.6	
	height	10 in.	15 in.	21 in.	25 in.	31 in.	38 in.	
1/4 in. Single Stream	gpm	1.2	1.5	1.8	2.0	2.2	2.5	
	psi	2	2.5	3.2	4	4.6	5.5	
	height	10 in.	16 in.	22 in.	27 in.	32 in.	40 in.	
5/16 in. Single Stream	gpm	1.5	1.9	2.3	2.6	2.9	3.2	
	psi	2	2.8	3.8	4.5	5.4	6.2	
	height	6 in.	9 in.	14 in.	17 in.	20 in.	25 in.	

ROGERS offers In-ground Pool Packages

STAINLESS STEEL WALLS

- * Stainless Steel + Concrete = Low Maintenance
- * Durable...Long-Lasting...Beautiful
- * Any Shape...Any Size...Any Custom Design
- * All Panels are pre-formed/pre-bent at factory
- * Perfect for Residential **and** Commercial Installation

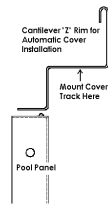

Special "Z" rim for automatic pool cover *under track* installation.

POLYMER WALLS

by HYDRA & PACIFIC

- * Non-corrosive...durable...long-lasting
- * Any Shape...Any Size...Any Custom Design
- * All Panels are pre-formed/pre-bent at factory
- * Large selection of liners available
- * Wide selection of steps available including:
Corner, radius, straight, Roman, wedding cake

GALVANIZED STEEL WALLS

- * Any Shape...Any Size...Any Custom Design
- * All Panels are pre-formed/pre-bent at factory
- * Large selection of liners available
- * Polymer and steel steps available

Rogers can price in-ground pool packages according to your requirements...complete or partial package or wall kit only.
800-752-5819

Call us for additional equipment and pricing.

STANDARD EQUIPMENT & SAFETY PACKAGE

Mechanical: (Sized to pool)
Pentair Sand Filter & Valve
Pentair WhisperFlo pump
Pentair SuperFlo pump



White Goods:

- 1-skimmer < 800 sq.ft. pool area
- 2-skimmers > 800 sq.ft. pool area
- 2-Return fittings w/eyeballs
- 1-Vacuum fitting
- 2- Main drains VGB



Lighting:

- 1-400w/120 V underwater light
- 1-Stainless Steel Light niche



Deck Equipment:

- 1-Stainless steel 3-Tread ladder
- 1-Channel deck anchor assembly
- 2-Stainless steel round escutcheons

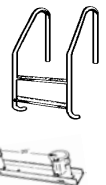

Diving pools:

- 1-S.R. Smith Flyte Deck dive board
- 1-Frontier diving board



Maintenance: (Diving Pools)

- 1-Safety rope kit
- 2-Rope anchors & rope hooks
- 1-Deluxe vacuum head
- 1-Leaf skimmer
- 1-18" pool brush
- 1-Vacuum hose
- 1-skim-vac plate
- 1-8' - 16' Telescoping pole
- 1-Automatic chlorinator
- 1-Test kit, 4-in-one

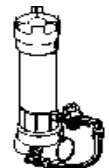

Safety Plus Pka:

**** INDIANA Code requires Safety Items to be installed according to code.**